

Comhairle Contae Chorcaí Cork County Council

Carrie Passmore,
c/o Rickard Roycroft,
Ceres Consulting,
Barleyfield,
Kilbrittain,
Co. Cork.

Pleanáil agus Forbairt,
Halla an Chontae,
Bóthar Charraig Ruacháin,
Corcaigh T12 R2NC.

Fón: (021) 4276891

R-phost: planninginfo@corkcoco.ie

Suíomh Gréasáin: www.corkcoco.ie

Planning & Development,

County Hall,

Carrigrohane Road, Cork T12 R2NC.

Tel (021) 4276891

Email: planninginfo@corkcoco.ie

Web: www.corkcoco.ie



21st September 2023

REF: D/275/23
LOCATION: Knockmacool, Enniskeane, Co. Cork

**RE: DECLARATION OF EXEMPTED DEVELOPMENT UNDER SECTION 5 OF THE
PLANNING & DEVELOPMENT ACT 2000 - 2010.**

Dear Madam,

On the basis of the information submitted by you on 23rd August 2023 the Planning Authority, having considered the question whether or not the construction of a Class 8 manure store and associated precast tank and a Class 10 outdoor exercise arena and covered horse walker at **Knockmacool, Enniskeane, Co. Cork** is or is not development and is or is not exempted development has declared that it **is development and is exempted development.**

Reason for Decision

The Planning Authority in considering this referral had particular regard to:

- Sections 3(1) and 4 of the Planning and Development Act 2000 (as amended)
- Classes 8 and 10 of the Planning and Development Regulations 2001 (as amended)
- Article 9 of the Planning and Development Regulations 2001 (as amended) and
- The particulars received by the Planning Authority on 23rd August 2023

And Whereas Cork County Council has concluded that –

The development of a Class 8 manure store and associated precast tank and a Class 10 outdoor exercise arena and covered horse walker at **Knockmacool, Enniskeane, Co. Cork** constitutes **development which is exempted development.**

This exemption does NOT itself empower a person to carry out a development unless that person is legally entitled to do so.



We are Cork.



Recycled

Please note that under Section 5 Subsection 3(a) where a declaration is issued under this section, any person issued with a declaration under subsection 2(a) may, on payment to the Board of such fee as may be prescribed, refer a declaration for review by the Board within 4 weeks of the date of the issuing of the declaration.

Yours faithfully,

KEVIN O' REGAN,
SENIOR EXECUTIVE OFFICER,
PLANNING DEPARTMENT.

In order to process your query, it may be necessary for Cork County Council to collect Personal information from you. Such information will be processed in line with our privacy statement which is available to view at <https://www.corkcoco.ie/privacy-statement-cork-county-council>

Planning Ref D/275/23

Declaration on Exempted Development under Section 5 of the Planning and Development Act 2000

Site Location:

Knockmacool, Bandon, Co. Cork

Proposed Development:

i) Is the construction of a Class 8 manure store (60m²) with precast tank (12.3m³) and a Class10 1238.1m² covered horse walker exempted development?

Proposal /Context

The applicant is seeking a determination by the planning authority as to whether or not the construction of Class 8 60m² manure store with 12.3m³ precast tank and a Class10 1238.1m² Covered horse walker is exempted development under the Planning and Development Regulations (2001, as amended).

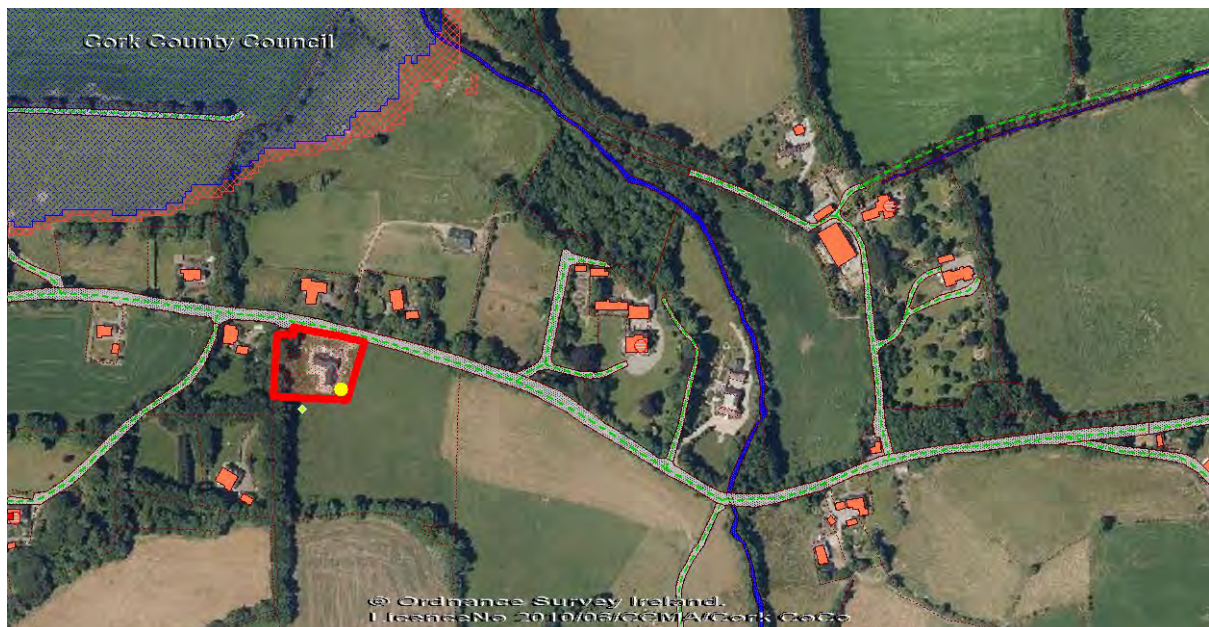

Planning History

None associated with the complex.

There is an existing stable block on the site measuring 196.7m²

There is a feed store and canopy measuring 41.4m².

Flooding and Appropriate Assessment

Site is not in a flood risk zone

The site not located in a Natura 2000 site or within a screening zone associated with a Natura 2000 site. Having regard to the scale of the project along with the conservation objectives for the site and the lack of direct or indirect connection between the proposal and any SAC & SPA, it is reasonable to conclude that the proposed development will not have significant impact on any Natura 2000 site.

Legislative Context

According to **Section 3(1) of the Planning and Development Act (2000 as amended)**, “development” means, save where the context otherwise requires, the carrying out of works on, in or under land or the making of any material change in the use of any structures or other land.

Section 4 of the same Act lists works that would be considered exempted development. It also conveys power on the Minister to make regulations to provide for any class of development to be exempted development for the purposes of the Act.

Of particular relevance to this application is **Schedule 2 Part 3** of the **Planning and Development Regulations (2001 as amended)**.

Class 8 of said Schedule considers

Works consisting of the provision of roofless cubicles, open loose yards, self feed silo or silage areas, feeding aprons, assembly yards, milking parlours or structures for the making or storage of silage or any other structures of a similar character or description, having an aggregate gross floor space not exceeding 200 square metres, and any ancillary provision for effluent storage.

1. No such structure shall be used for any purpose other than the purpose of agriculture.
2. The gross floor space of such structures together with any other such structures situated within the same farmyard complex or within 100 metres of that complex shall not exceed 300 square metres gross floor space in aggregate.
3. Effluent storage facilities adequate to serve the structure having regard to its size, use and location shall be constructed in line with Department of Agriculture, Food and Rural

Development and the Department of the Environment and Local Government requirements and shall have regard to the need to avoid water pollution.

4. No such structure shall be situated, and no effluent from such structure shall be stored, within 10 metres of any public road.

5. No such structure within 100 metres of any public road shall exceed 8 metres in height.

6. No such structure shall be situated, and no effluent from such structure shall be stored, within 100 metres of any house (other than the house of the person providing the structure) or other residential building or school, hospital, church or building used for public assembly, save with the consent in writing of the owner and, as may be appropriate, the occupier or person in charge thereof.

7. No unpainted metal sheeting shall be used for roofing or on the external finish of the structure.

Class 10 of said Schedule considers

The erection of an unroofed fenced area for the exercising or training of horses or ponies, together with a drainage bed or soft surface material to provide an all-weather surface

Conditions and Limitations

1. No such structure shall be used for any purpose other than the exercising or training of horses or ponies.

2. No such area shall be used for the staging of public events.

3. No such structure shall be situated within 10 metres of any public road, and no entrance to such area shall be directly off any public road.

4. The height of any such structure shall not exceed 2 metres.

Article 9 of said Regulations lists a series of restrictions on exemptions which includes

(a) if the carrying out of such development would—

(i) contravene a condition attached to a permission under the Act or be inconsistent with any use specified in a permission under the Act.

(ii) consist of or comprise the formation, laying out or material widening of a means of access to a public road the

surfaced carriageway of which exceeds 4 metres in width,

- (iii) endanger public safety by reason of traffic hazard or obstruction of road users,
- (iv) except in the case of a porch to which class 7 specified in column 1 of Part 1 of Schedule 2 applies and which complies with the conditions and limitations specified in column 2 of the said Part 1 opposite the mention of that class in the said column 1, comprise the construction, erection, extension or renewal of a building on any street so as to bring forward the building, or any part of the building, beyond the front wall of the building on either side thereof or beyond a line determined as the building line in a development plan for the area or, pending the variation of a development plan or the making of a new development plan, in the draft variation of the development plan or the draft development plan,
- (v) consist of or comprise the carrying out under a public road of works other than a connection to a wired broadcast relay service, sewer, water main, gas main or electricity supply line or cable, or any works to which class 25, 26 or 31 (a) specified in column 1 of Part 1 of Schedule 2 applies,
- (vi) interfere with the character of a landscape, or a view or prospect of special amenity value or special interest, the preservation of which is an objective of a development plan for the area in which the development is proposed or, pending the variation of a development plan or the making of a new development plan, in the draft variation of the development plan or the draft development plan,
- (vii) consist of or comprise the excavation, alteration or demolition (other than peat extraction) of places, caves, sites, features or other objects of

archaeological, geological, historical, scientific or ecological interest, the preservation of which is an objective of a development plan for the area in which the development is proposed or, pending the variation of a development plan or the making of a new development plan, in the draft variation of the development plan or the draft development plan, save any excavation, pursuant to and in accordance with a licence granted under [section 26](#) of the [National Monuments Act, 1930](#) (No. 2 of 1930),

- (viii) consist of or comprise the extension, alteration, repair or renewal of an unauthorised structure or a structure the use of which is an unauthorised use,
- (ix) consist of the demolition or such alteration of a building or other structure as would preclude or restrict the continuance of an existing use of a building or other structure where it is an objective of the planning authority to ensure that the building or other structure would remain available for such use and such objective has been specified in a development plan for the area or, pending the variation of a development plan or the making of a new development plan, in the draft variation of the development plan or the draft development plan,
- (x) consist of the fencing or enclosure of any land habitually open to or used by the public during the 10 years preceding such fencing or enclosure for recreational purposes or as a means of access to any seashore, mountain, lakeshore, riverbank or other place of natural beauty or recreational utility,
- (xi) obstruct any public right of way,
- (xii) further to the provisions of section 82 of the Act, consist of or comprise the carrying out of works to the exterior of a structure, where the structure concerned is located within an architectural conservation area or an area specified as

an architectural conservation area in a development plan for the area or, pending the variation of a development plan or the making of a new development plan, in the draft variation of the development plan or the draft development plan and the development would materially affect the character of the area,

- (b) in an area to which a special amenity area order relates, if such development would be development: —
 - (i) of class 1, 3, 11, 16, 21, 22, 27, 28, 29, 31, (other than paragraph (a) thereof), 33
 - (c) (including the laying out and use of land for golf or pitch and putt or sports involving the use of motor vehicles, aircraft or firearms), 39, 44 or 50(a) specified in column 1 of Part 1 of Schedule 2, or
 - (ii) consisting of the use of a structure or other land for the exhibition of advertisements of class 1, 4, 6, 11, 16 or 17 specified in column 1 of Part 2 of the said Schedule or the erection of an advertisement structure for the exhibition of any advertisement of any of the said classes, or
 - (iii) of class 3, 5, 6, 7, 8, 9, 10, 11, 12 or 13 specified in column 1 of Part 3 of the said Schedule, or
 - (iv) of any class of Parts 1, 2 or 3 of Schedule 2 not referred to in subparagraphs (i), (ii) and (iii) where it is stated in the order made under section 202 of the Act that such development shall be prevented or limited,
- (c) if it is development to which Part 10 applies, unless the development is required by or under any statutory provision (other than the Act or these Regulations) to comply with procedures for the purpose of giving effect to the Council Directive,
- (d) if it consists of the provision of, or modifications to, an establishment, and

could have significant repercussions on major accident hazards.

- (2) Sub-article (1)(a)(vi) shall not apply where the development consists of the construction by any electricity undertaking of an overhead line or cable not exceeding 100 metres in length for the purpose of conducting electricity from a distribution or transmission line to any premises.

Assessment

The applicant is seeking a determination by the planning authority as to whether or not the construction of Class 8 60m² manure store building and a Class10 1238.1m² Covered horse walker is exempted development under the Planning and Development Regulations (2001, as amended).

Class 8 60m² Manure Store Building

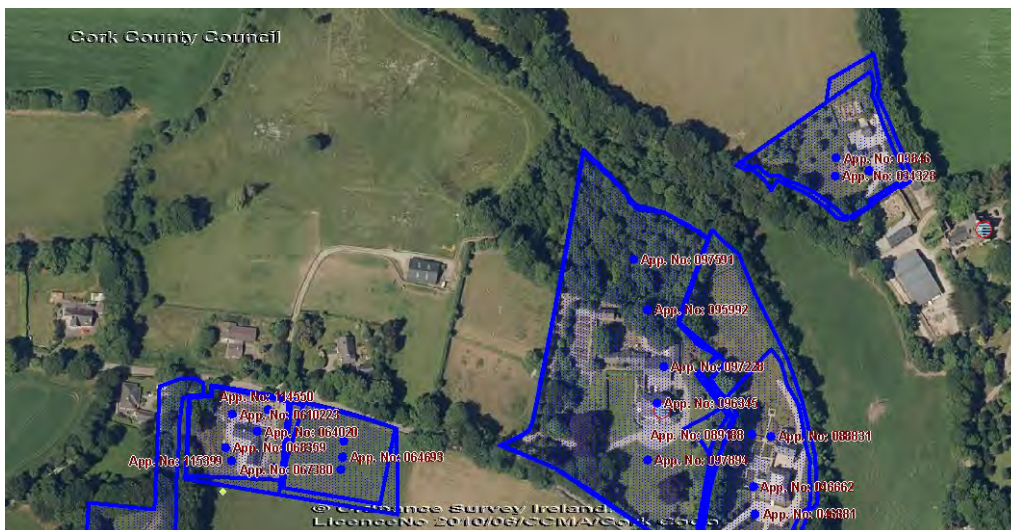

The proposed manure store is located to the north of the existing stables. It is noted that the existing shed is located circa 75m north west of a dwelling (P47 FF25). As per condition no

5. No such structure shall be situated within 100 metres of any house (other than the house of the person providing the structure) or other residential building or school, hospital, church or building used for public assembly, save with the consent in writing of the owner and, as may be appropriate, the occupier or person in charge thereof.

The applicant has submitted a letter from the owner of the dwelling to the south who has no issue with the outdoor exercise area, outdoor walker or manure store. There is no other third party dwelling within 100m of the manure store.

Class 10 Covered horse walker (unroofed) circle 113m and Outdoor Exercise yard 1125m². The unroofed walker will be 113m. It will be unroofed. The applicant is proposing a 1125m² outdoor exercise yard with 1.2m high fencing around it. The proposal complies with the Class 10 conditions and limitations.

Environmental Officer

The construction of the outdoor exercise arena and unroofed horse walker appear to meet the conditions/limitations for Class 10 developments. There is not a requirement to provide effluent storage facilities under the Conditions/Limitations for a Class 10 development. The construction of a manure store with effluent tank is consistent with the requirements of a stable building and associated facilities such as those proposed in the current application. All proposed structures should be constructed in compliance with current Dept. of Agriculture, Food and the Marine specifications.

Conclusion

The proposed Class 8 Manure Store and Class 10 Covered horse walker (unroofed) circle 113m and Outdoor Exercise yard 1125m² are considered development however they are considered exempted development having regard to Class 8 and Class 10 of Schedule 2 Part 3 of the Planning and Development Regulations (2001 as amended).

John Redmond
Area Planner
19/09/2023

Application for Planning Exemption

Reference: D/275/23

Applicant: Carrie Passmore

Address: Knockmacool, Enniskeane, Co. Cork

Date: 18th Sept '23

By: Kevin Murphy

Existing Site

The existing stables includes 4 no. boxes for horses and areas for the storage of horse tackle and other equipment. There is currently no facility for the collection and storage of stable manure generated in the stable building. Manure was being stored on the north side of the stables at the time of my inspection on 30/05/23 with no facility for the collection and storage of soiled water runoff.

Previous applications for planning exemption, D/243/23 & D/252/23, indicated that there was no facility for the collection and storage of liquid effluents/wash water from the stables. Existing soiled water tank "1" is shown in the current application.

Land Registry details for Folio CK153542F shows a 5.99Ha landholding. The Applicant's name is not currently on the folio; applications are pending on the folio.

Details of Application

The application for planning exemption for Class 10 development relates to:

- Construction of a Horse Walker (Circle).
- Construction of an outdoor exercise arena with fence around.
- Construction of a manure store (60m²) with precast tank (12.3m³).

Existing structures, including the stable building, have not been included in the application for planning exemption.

The construction of the outdoor exercise arena and unroofed horse walker appear to meet the conditions/limitations for Class 10 developments. There is not a requirement to provide effluent storage facilities under the Conditions/Limitations for a Class 10 development.

Conclusions

1. The construction of a manure store with effluent tank is consistent with the requirements of a stable building and associated facilities such as those proposed in the current application.

2. All proposed structures should be constructed in compliance with current Dept. of Agriculture, Food and the Marine specifications.

END

Planning Department,
Cork County Council,
County Hall,
Cork.
T12 R2NC

17 August 2023

RE: Application for Agricultural Planning Exemption under Class 8 & 10.

Carrie Passmore, Knockmacool, Bandon, Co. Cork.

Dear Sir / Madam,

Please find enclosed the following in relation to the above application:

- 4 no. copies – Application Form.
- 1 no. copy – Contact Details.
- 4 copies – Structures Sheet.
- 4 copies – Location Map Scale 1:10,560
- 4 copies – Location Map Scale 1:2,500
- 4 copies – Site Layout Plan Scale 1:500
- 4 copies – Drawings & Elevations
- €80 application fee.
- Letter from owner of adjoining property within 100m
- Proposed structures have been moved so that they are more than 100m from residence to east of farmyard.
- Letter from applicant stating that proposed structures will only be used for exercising & training of horses and will not be used for public events.

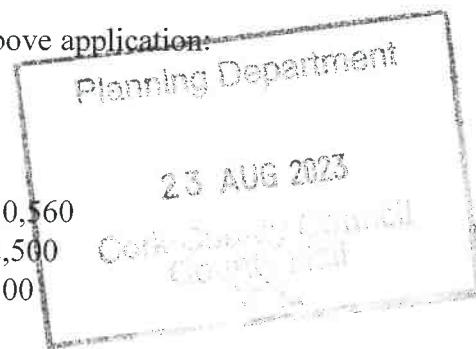

Please note the following:

- A. There is an existing soiled water tank (1) (5.76m³) in structure B to cater for soiled water from the existing building.
- B. In addition to items listed on the structures sheet a new Class 8 manure store 'X' (60m²) with precast tank '2' (12.3m³) is proposed. This is to address the issues raised on CCC letter dated 24th July for application D/252/23
- C. Total for proposed Class 10 structure is 1238.10m² - namely an outdoor exercise arena and unroofed horse walker.

We believe this application addresses issues previously raised but if you have any queries, please do not hesitate to contact us directly to discuss.

Ceres Consulting

Consultants in Agriculture

Yours Sincerely,

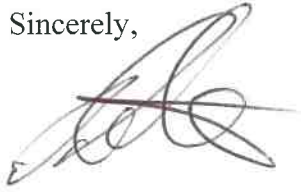

Ricky Roycroft BSc. Agri. Bus. (Hons.)

Barleyfield, Kilbrittain, Co. Cork

Phone: 023 8849000

Mobile: 087 2804202

Email: info@ceres.ie





CORK COUNTY COUNCIL APPLICATION FOR SECTION 5 DECLARATION OF EXEMPTION

APPLICANT CHECKLIST

(Please tick ✓)

- 4 No. Copies of Application Form:**
- 1 No. Copy of Contact Details:**
- 4 No. Copies 6" O.S. Maps:**
- 4 No. Copies 25" O.S. Maps:**
- 4 No. Copies of Site Layout Plan:**
- 4 No. Copies Scaled Drawings of Development:**
- €80 Application Fee:**

✓
✓
✓
✓
✓
✓
✓

FOR OFFICE USE ONLY

Receipt No.	P2-0002293
Cash/Cheque/ Credit Card	Cheque
Date	23/8/2023
Declaration Ref. No.	D/275/23

DATE STAMP HERE

You should make sure that you are satisfied that any information/documentation that you submit is appropriate to be viewed by the public. Please do not submit any information that you do not want 3rd parties to view.

In the case of a Declaration of Exemption for Land Reclamation, the following additional information is required:

- A copy of the details submitted to the Council's Environment Department (Inniscarra) for a Waste Licence Permit
- Correspondence from Teagasc (detailing how the land reclamation would benefit the land in question for agricultural purposes)
- Details of existing and proposed levels
- Details of fill material and duration of fill.

DATA PROTECTION

The planning process is an open and public one. In that context, all applications for Declarations of Exemption are made available for public inspection.

Personal information collected by Cork County Council is done so in order for us to process your application for a Section 5 Declaration of Exemption. Legally we can process this information as it is necessary for us to comply with our statutory/legal obligations. The protection of our personal data is a key priority for the Council and your data will be processed in line with our Privacy policy which is available at <http://www.corkcoco.ie/Privacy-Policy> or hardcopy from our offices at County Hall, Carrigrohane Road, Cork, Ireland. Should you have any questions about our privacy policy or the information we hold about you, please contact us by email to dpo@corkcoco.ie or write to us at Data Protection Officer, Cork County Council, County Hall, Carrigrohane Road, Cork, Ireland.

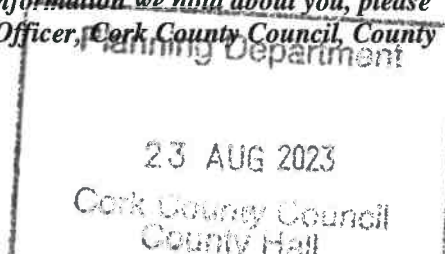

4. APPLICATION DETAILS:

Answer the following if applicable. Note: Floor areas are measured from the inside of the external walls and should be indicated in square metres (m²)

(a) Floor area of existing/proposed structure(s):	Class 8 prop. 60m ² & precast tank, Class 10 - Prop. 1238.1m ²
(b) If a domestic extension is proposed, have any previous extensions/structures been erected at this location after 1 st October, 1964 (including those for which planning permission has been obtained):	Yes <input type="checkbox"/> No <input checked="" type="checkbox"/> If yes, please provide floor areas (m ²) and previous planning reference(s) where applicable:
(c) If a change of use of land and/or building(s) is proposed, please state the following: Existing/previous use N/A	Proposed use N/A
(d) Are you aware of any enforcement proceedings connected to this site?	Yes <input type="checkbox"/> No <input checked="" type="checkbox"/> If yes, please state relevant reference number(s):

5. LEGAL INTEREST OF APPLICANT IN THE LAND/STRUCTURE:

Please tick appropriate box to show applicant's legal interest in the land or structure:	A. Owner <input checked="" type="checkbox"/>	B. Other <input type="checkbox"/>
Where legal interest is "Other", please state your interest in the land/structure:		
If you are not the legal owner, please state the name of the owner/s (address to be supplied at Question C in Contact Details):		

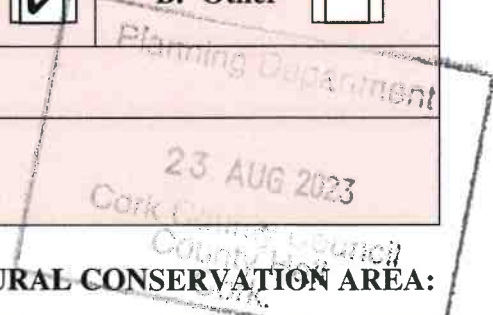

6. PROTECTED STRUCTURE DETAILS / ARCHITECTURAL CONSERVATION AREA:

Is this a Protected Structure/Proposed Protected Structure or within the curtilage of a Protected Structure: Yes <input type="checkbox"/> No <input checked="" type="checkbox"/>
If yes, has a Declaration under Section 57 of the Planning & Development Act 2000 been requested or issued for the property by the Planning Authority: Yes <input type="checkbox"/> No <input type="checkbox"/>
If yes, please state relevant reference No. _____
Is this site located within an Architectural Conservation Area (ACA), as designated in the County Development Plan? Yes <input type="checkbox"/> No <input checked="" type="checkbox"/>

7. APPROPRIATE ASSESSMENT:

Would the proposed development require an appropriate assessment because it would be likely to have a significant effect on the integrity of a European site (SAC, SPA etc)? Yes No

8. DATA PROTECTION DECLARATION:

In order for the Planning Authority to process the personal data you have provided, your consent is required. By ticking the box below, you consent to the Planning Authority processing the personal data provided by you in line with the terms of Cork County Council's Privacy Policy available at <http://www.corkcoco.ie/privacy-statement-cork-county-council> or in hardcopy from any Council office; and to having your information processed for the following purposes:

Processing of your Declaration of Exemption application by the Planning Authority

I give permission for my personal information to be processed for the purpose stated above

Signed (By Applicant Only)	<i>Conor Pasmore</i>
Date	17-08-2023

GDPR Special Categories of data / Sensitive Personal data - Explicit Consent

Where Special Categories of personal data / sensitive personal data are provided as part of / in support of a declaration application, **explicit consent** to the processing of the special categories of data must be given by the person to whom the data refers, namely the Data Subject.

Special Categories of data / Sensitive Personal data include:

- Race
- Ethnic origin
- Political opinions
- Religion
- Philosophical beliefs
- Trade union membership
- Genetic data
- Biometric data
- Health data
- Concerning a natural person's sex life
- Sexual orientation

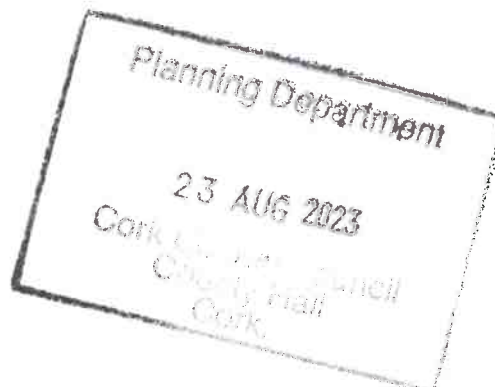

In order for the Planning Authority to process the sensitive personal data you have provided, your consent is required. By ticking the box below, you consent to the Planning Authority processing the personal data provided by you in line with the terms of Cork County Council's Privacy Policy available at <https://www.corkcoco.ie/privacy-statement-cork-county-council> or in hardcopy from any Council office; and to having your information processed for the following purposes:

Sensitive personal data being submitted in support of Declaration of Exemption Application

I give permission for my sensitive personal data submitted to the Planning Authority to be processed for the purpose stated above.

Signed	
Date	

You have the right to withdraw your consent by contacting the Planning Department, Ground Floor, County Hall, Carrigrohane Road, Cork. Tel: (021) 4276891 Email: planninginfo@corkcoco.ie or by contacting the Planning Department, Norton House, Cork Road, Skibbereen, Co. Cork. Tel: (028) 40340 Email: westcorkplanninginfo@corkcoco.ie However if consent to the use of personal data is withdrawn during the declaration of exemption decision-making process this information cannot be considered as part of the decision making process. Once a decision has been made, an applicant is not entitled to withdraw consent, as the right of erasure does not apply to a situation where processing is required for compliance with a legal obligation or for the performance of a task carried out in the public interest.

Please note that all information / supporting documentation submitted will be available publicly to view at the Planning Authority offices.

ADVISORY NOTES:

The application must be accompanied by the required fee of €80
 The application must be accompanied by a site location map which is based on the Ordnance Survey map for the area, is a scale not less than 1:1000 and it shall clearly identify the site in question.
 Sufficient information should be submitted to enable the Planning Authority to make a decision. If applicable, any plans submitted should be to scale and based on an accurate survey of the lands/structure in question.
 The application should be sent to the following address:
 The Planning Department, Cork County Council, Floor 2, Co. Hall, Carrigrohane Road, Cork, T12 R2NC; or for applications related to the Western Division, The Planning Department, Cork County Council, Norton House, Cork Road, Skibbereen, Co. Cork, P81 AT28.

- The Planning Authority may require further information to be submitted to enable the authority to issue a decision on the Declaration of Exemption application.
- The Planning Authority may request other person(s), other than the applicant; to submit information on the question which has arisen and on which the Declaration of Exemption is sought.
- Any person issued with a Declaration of Exemption may on payment to An Bord Pleanála refer a Declaration of Exemption for review by the Board within 4 weeks of the date of the issuing of the Declaration of Exemption decision.
- In the event that no Declaration of Exemption is issued by the Planning Authority, any person who made a request may on payment to the Board of such a fee as may be prescribed, refer the question for decision to the Board within 4 weeks of the date that a Declaration of Exemption was due to be issued by the Planning Authority.

The application form and advisory notes are non-statutory documents prepared by Cork County Council for the purpose of advising the type of information which is normally required to enable the Planning Authority to issue a Declaration of Exemption under Section 5. This document does not purport to be a legal interpretation of the statutory legislation nor does it state to be a legal requirement under the Planning and Development Act 2000 as amended, or Planning and Development Regulations, 2001, as amended.

9. I hereby declare that, to the best of my knowledge and belief, the information given in this form is correct, accurate and fully compliant with the Planning and Development Acts 2000, as amended and the Regulations made thereunder:

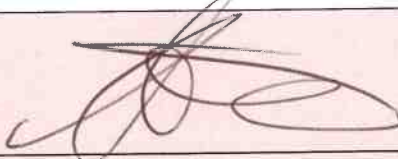
<i>Signed (Applicant or Agent as appropriate)</i>	
Date	17-Aug-2023



Knockmacool
Enniskeane
Co. Cork

17th August 2023

Planning & Development
County Hall
Carrigrohane
Cork
T12 R2NC

Re: **Planning exemption application on behalf of Carrie Passmore.**

Dear Sir /Madam,

I refer to planning exemption to the attached planning exemption application and wish to confirm the following:

1. I confirm that the proposed all-weather surface equine outdoor exercise arena and horse walker will not be used for any purpose other than the exercising or training of horses or ponies.
2. I confirm that the proposed all-weather surface equine outdoor exercise arena and horse walker will not be used for the staging of public events.

If you have any further queries, please do not hesitate to contact me.

Yours sincerely,

Carrie Passmore.

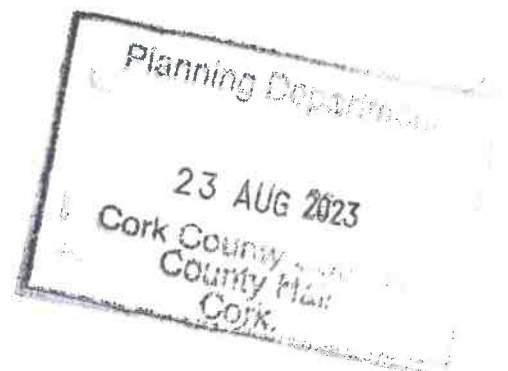

Knockmacool
Enniskeane
Co. Cork
P47 FF25

17th August 2023

Planning Department,
Cork County Council,
County Hall,
Cork.
T12 R2NC

Re: Installation of outdoor exercise area, outdoor horse walker and manure store at Knockmacool, Enniskeane, Co. Cork

To whom it may concern,

I, Claire Horgan, reside at Knockmacool, Enniskeane, Co. Cork P47 FF25 which is adjacent to lands owned by my neighbour, Carrie Passmore.

I can hereby confirm that I have no objection to her proposed development of an outdoor horse arena, outdoor horse walker and manure store.

Yours sincerely,

Claire Horgan



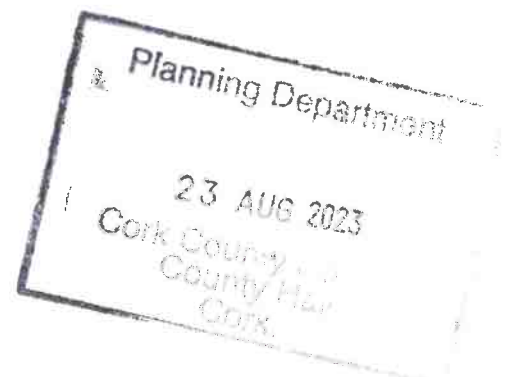

Farm Structures List. -

Carrie Passmore, Knockmacool, Enniskeane, Co. Cork

Class 6 ANIMAL HOUSING							Class 10 Horse Arena, Horse Walker etc						Class 9 STORAGE BUILDINGS; CLEAN YARDS					
ID No.	Description of Structure	Animal Type	Length(m)	Width(m)	Area(m2)		ID No.	Description of Structure	Discharge to: (ID No.)	Length(m)	Width(m)	Area(m2)	ID No.	Description of Structure	Length(m)	Width(m)	Area(m2)	
A. EXISTING STRUCTURES IN FARMYARDS							A. EXISTING STRUCTURES IN FARMYARDS						A. EXISTING STRUCTURES IN FARMYARDS					
A	Stable Block	Horse	18.2	10.8	196.7								0	B	Feed Store	2.0	3.4	6.8
														C	Canopy	18.2	1.8	32.8
					196.7						0.0						39.6	

B. PROPOSED NEW STRUCTURES							B. PROPOSED NEW STRUCTURES						B. PROPOSED NEW STRUCTURES							
							E	Horse Walker (Circle)												
							F	Outdoor Exercise Arena		45.0	25.0	1125.00								
					Total:	196.7						Total:	1238.10						Total:	39.6

C. Existing Slurry and Soiled Water Stores.							
ID No.	Description (open, slatted, precast, etc)	Effluent type stored	Length(m)	Width(m)	Depth(m)	Vol.(m3)	
1	Precast tank	Soiled water	2.4	2.4	1.00	5.76	
						Total:	5.76

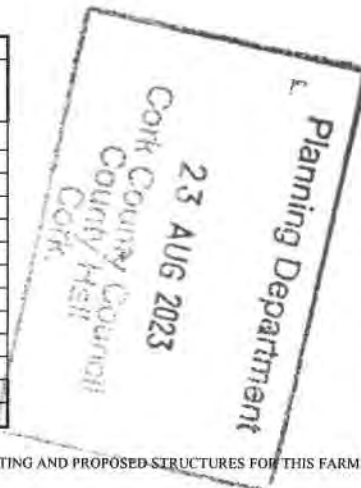

D. Proposed Slurry and Soiled Water Stores.							
ID No.	Description (open, slatted, precast, etc)	Effluent type stored	Length (m)	Width(m)	Depth(m)	Gross Vol.(m3)	
2.00	Precast tank	Soiled water				12.30	
						Total:	12.30

WE HEREBY DECLARE THAT THE ABOVE INFORMATION AND THE ACCOMPANYING LAYOUT PLAN ARE A TRUE RECORD OF EXISTING AND PROPOSED STRUCTURES FOR THIS FARM.

PREPARED BY:

[Signature]
Rickard Roycroft, BSc Agri Bus. (Hons)

Carrie Passmore, Killoomanpark, Ennisheane, Co. Cork.

Site Address: Knockmacool, Ennisheane, Co. Cork.

Site Layout.

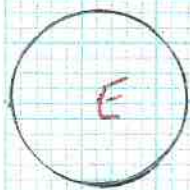
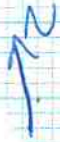

② - Proposed precast tank - 12.3m³

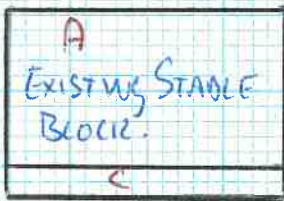

① Existing precast tank 2.4m x 2.4m x 1m

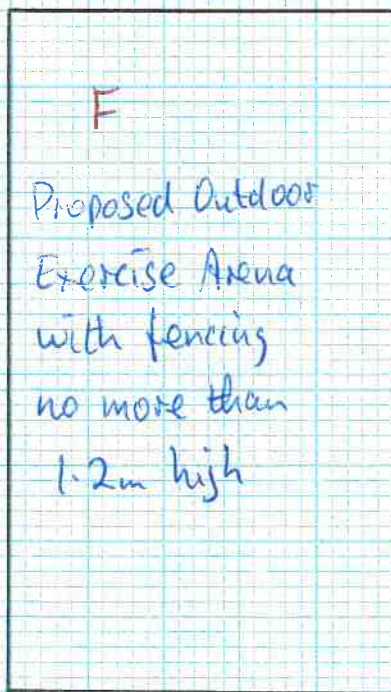

Scale 1:500

Carrie Pussmore, Kildolemanpark, Enniskane, Co. Cork.

Site address: Knockmacool, Enniskane, Co. Cork.

Floor Plan - Outdoor exercise arena

Scale 1:200

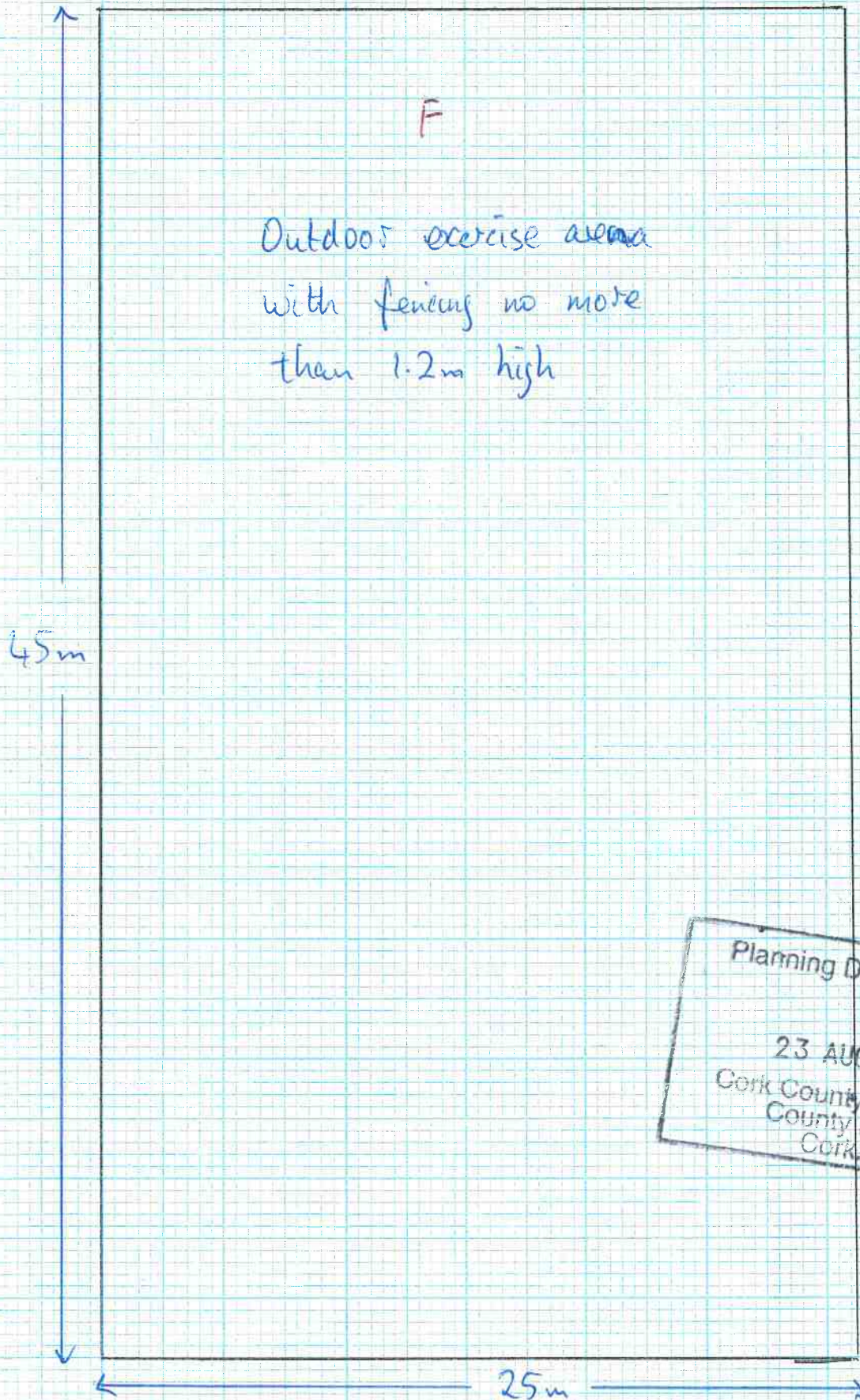

Carrie Passmore, Killoleamanpark, Ennisheane, Co. Lork.

Site Address: Knochmacool, Ennisheane, Co. Lork.

Floor Plan - Horse Walker (unroofed)

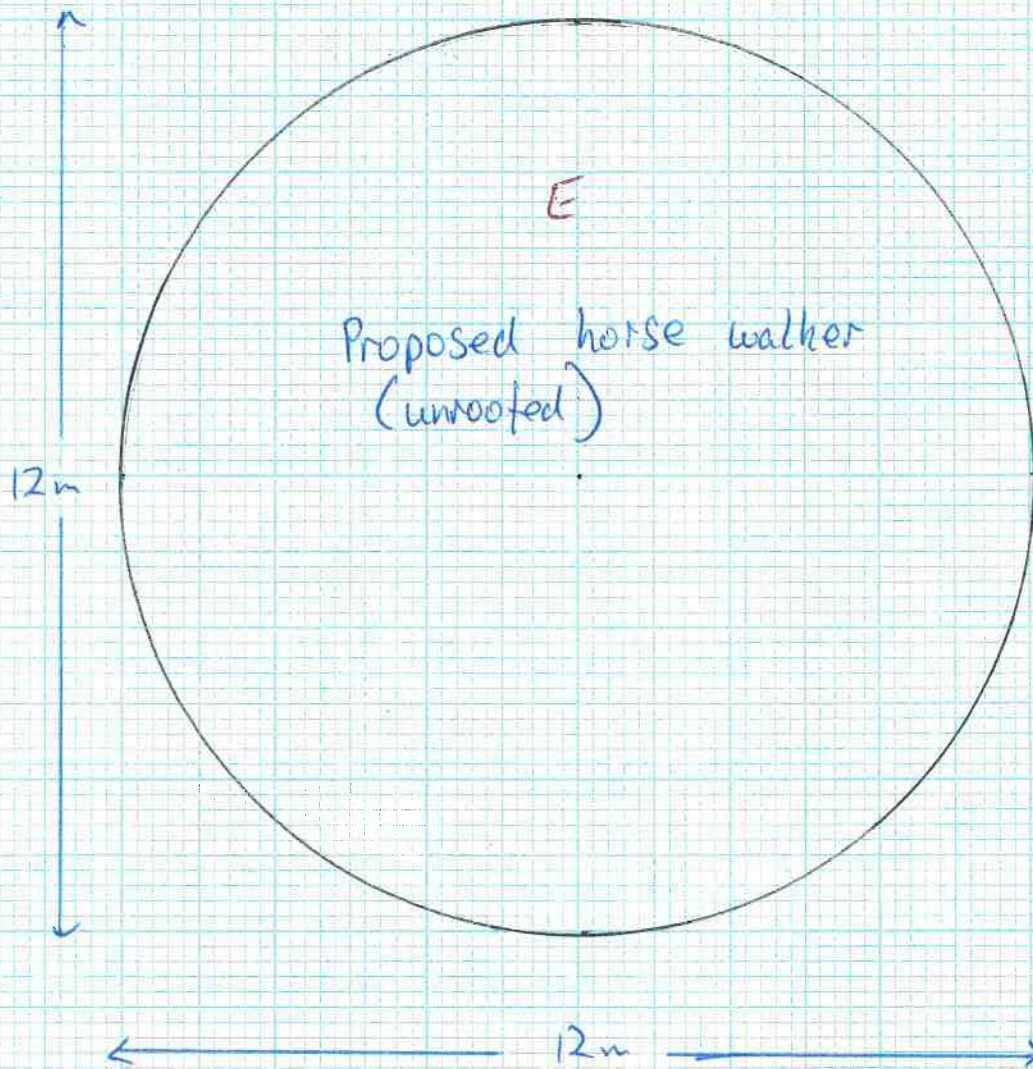

Planning Department
23 AUG 2023
Cork County Council
County Hall
Cork.

Scale 1:100

Carrie Passmore, Kilcolemanpcok, Ennishaano, Co. Cork.

Site Address: Knockmacool, Ennishaano, Co. Cork.

Floor plan - Manure Store + Precast tank.

Scale 1:100

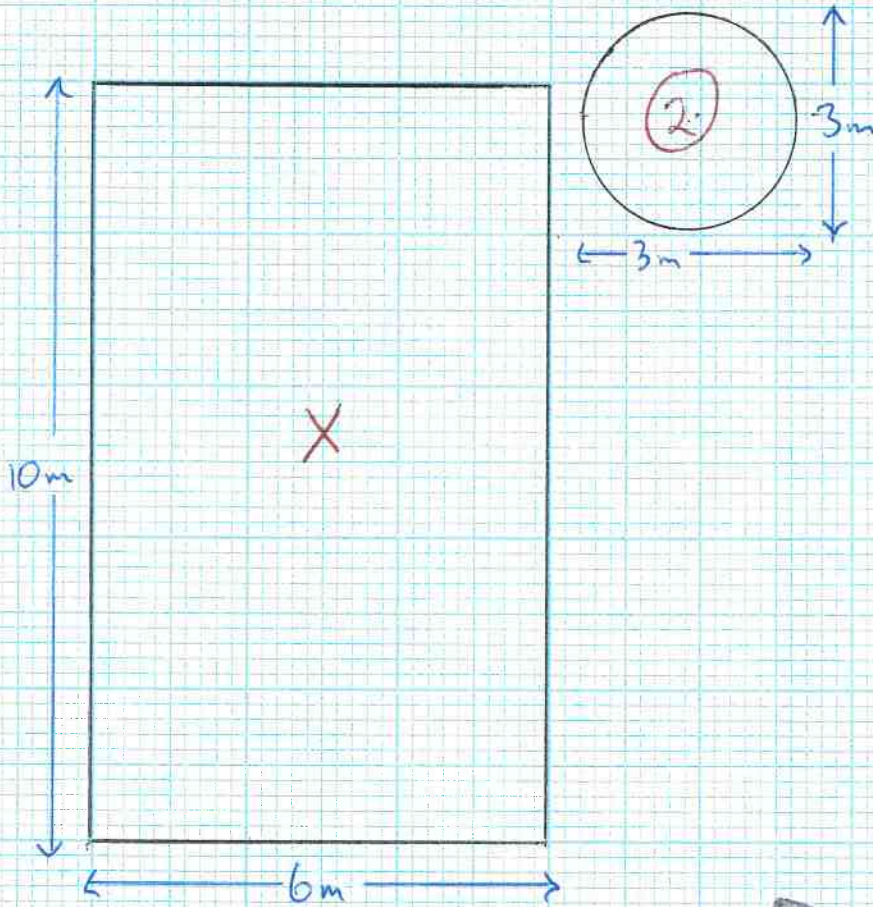

Planning Department
23 AUG 2023
Cork County Council
County Hall
Cork.

Site Location Map



Tailte Éireann

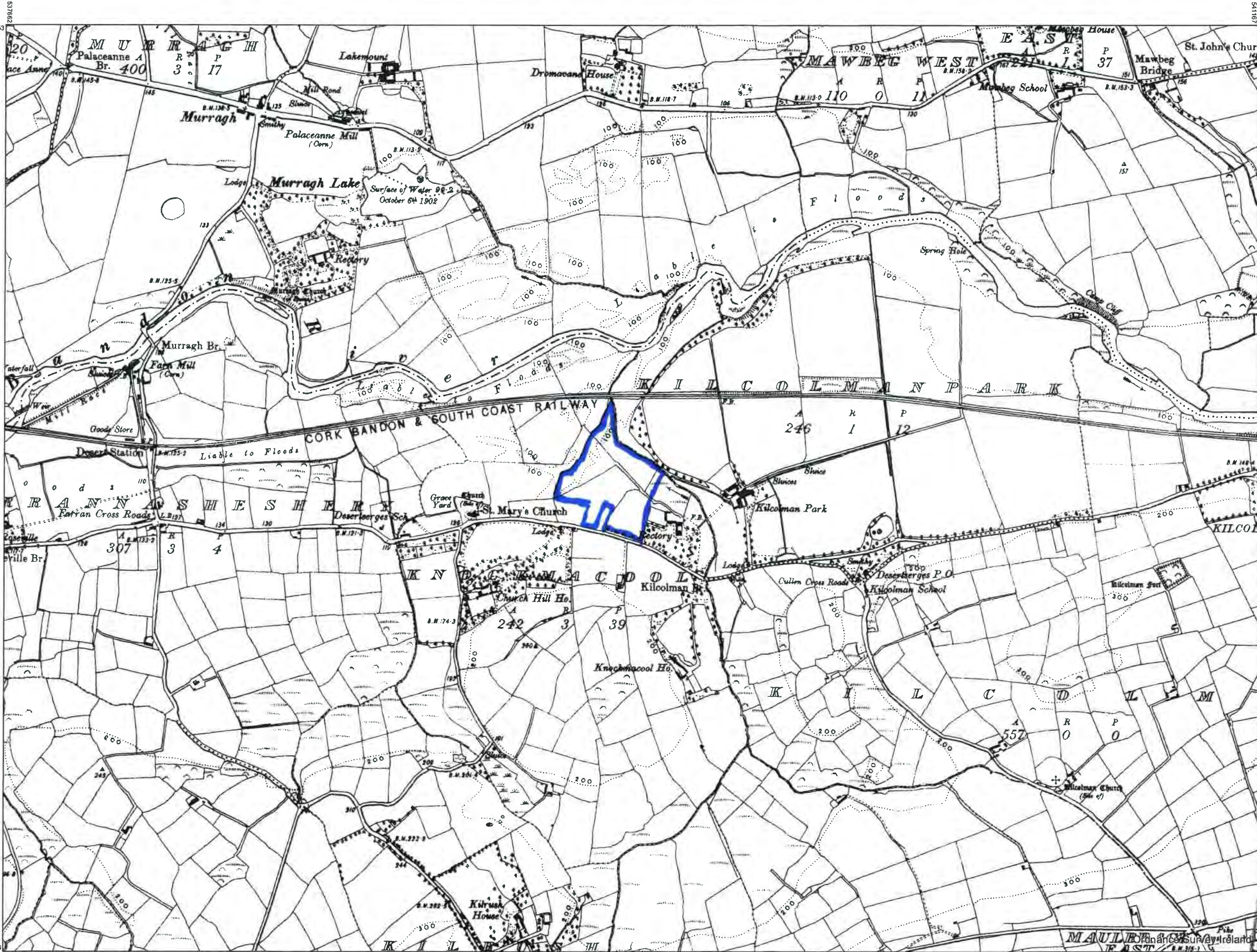

CENTRE COORDINATES:
ITM 539415,553755

PUBLISHED:
10/05/2023

ORDER NO.:
50333797_1

MAP SERIES:
6 Inch Raster

MAP SHEETS:
CK109

COMPILED AND PUBLISHED BY:
National Mapping Division of Tailte Éireann,
Phoenix Park,
Dublin 8,
Ireland.
D08F6E4

www.tailte.ie

Any unauthorised reproduction infringes Tailte Éireann copyright.

No part of this publication may be copied, reproduced or transmitted in any form or by any means without the prior written permission of the copyright owner.

The representation on this map of a road, track or footpath is not evidence of the existence of a right of way.

Topographic maps produced by the National Mapping Division of Tailte Éireann never show legal property boundaries, nor do they show ownership of physical features.

© National Mapping Division of Tailte Éireann, 2023. All rights reserved.

23 AUG 2023
Cork County Council
County Hall
Cork.

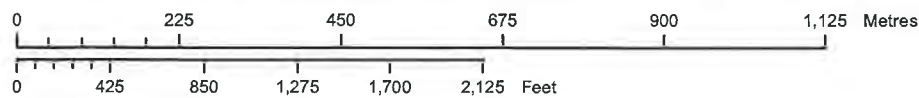

OUTPUT SCALE: 1:10,560

CAPTURE RESOLUTION:
The map objects are only accurate to the resolution at which they were captured. Output scale is not indicative of data capture scale. Further information is available at: www.osi.ie; search 'Capture Resolution'

LEGEND:
To view the legend visit www.osi.ie and search for 'Large Scale Legend'



This map was produced by the National Mapping Division of Tailte Éireann, formerly Ordnance Survey Ireland (OSI)

Planning Pack Map



Tailte Éireann

CENTRE COORDINATES:
ITM 539415,553755

PUBLISHED:
10/05/2023

ORDER NO.:
50333797_1

MAP SERIES:
1:5,000

MAP SHEETS:
6604

COMPILED AND PUBLISHED BY:
National Mapping Division of Tailte Éireann,
Phoenix Park,
Dublin 8,
Ireland.
D08F6E4
www.tailte.ie

Any unauthorised reproduction infringes Tailte Éireann copyright.

No part of this publication may be copied, reproduced or transmitted in any form or by any means without the prior written permission of the copyright owner.

The representation on this map of a road, track or footpath is not evidence of the existence of a right of way.

Topographic maps produced by the National Mapping Division of Tailte Éireann never show legal property boundaries, nor do they show ownership of physical features.

© National Mapping Division of Tailte Éireann, 2023. All rights reserved.

Planning Department

23 AUG 2023
Cork County Council
County Hall
Cork.

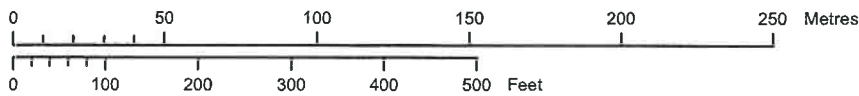
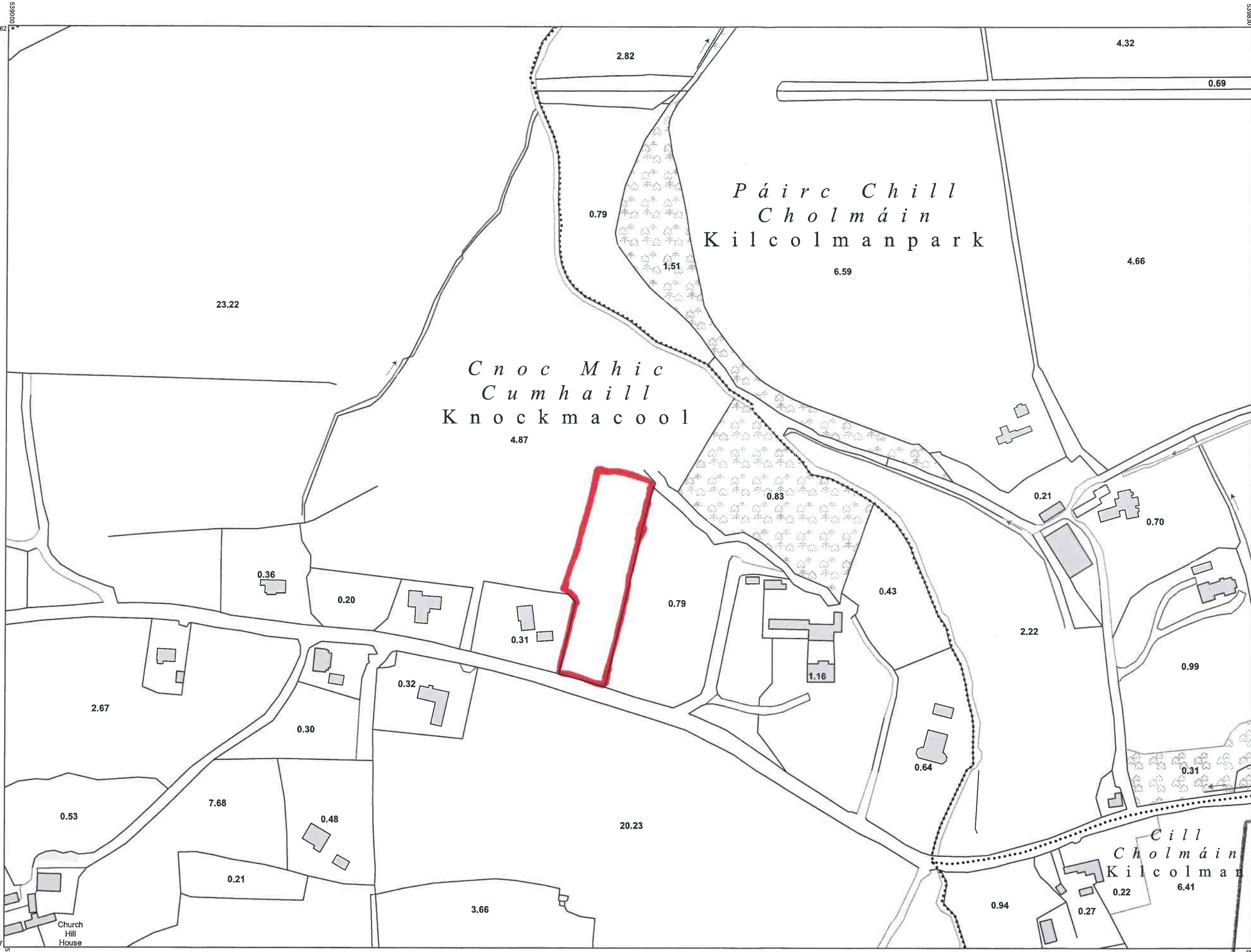

OUTPUT SCALE: 1:2,500

CAPTURE RESOLUTION:
The map objects are only accurate to the resolution at which they were captured. Output scale is not indicative of data capture scale. Further information is available at: www.osi.ie; search 'Capture Resolution'

LEGEND:
To view the legend visit www.osi.ie and search for 'Large Scale Legend'



i This map was produced by the National Mapping Division of Tailte Éireann, formerly Ordnance Survey Ireland (OSI)