



CORK COUNTY COUNCIL

PLANNING GUIDANCE
AND STANDARDS
SERIES

number

1

DECEMBER 2003



CORK RURAL DESIGN GUIDE: Building a New House in the Countryside

AUTHORS

COLIN BUCHANAN AND PARTNERS
LTD.

and

MIKE SHANAHAN + ASSOCIATES,
ARCHITECTS

PLANNING DEPARTMENT
ARCHITECTS DEPARTMENT





TECHNICAL INFORMATION

First Published by Cork County Council 2003

Copyrights © 2003, 2004, 2006, 2010

Colin Buchanan and Partners Ltd

Mike Shanahan + Associates, Architects

Cork County Council

All rights reserved. No part of this document may be reproduced in any form (including by storage in any retrieval system), transmitted by any means, electronic, mechanical, photocopying, or otherwise, or adapted without the prior written permission of the authors and publishers.

TITLE:

PLANNING STANDARDS AND
GUIDANCE SERIES, No. 1:
Cork Rural Design Guide. Building a New
House in the Countryside
ISBN No. 0 9525 8694 0

VERSION:

REPRINTED DECEMBER 2003 WITH
CORRECTIONS FEBRUARY 2004
AND UPDATED JULY 2010



Published by Cork County Council 2003

Reprinted December 2003 with Corrections February 2004 and Updated July 2010

A joint production of the Cork County Architect and the Planning Policy Unit.

Cork County Council would be pleased to receive any comments on the contents and utility of the guide, and especially any suggestions as to how it could be improved.

Any comments should be sent to:
Planning Policy Unit,
Floor 13
County Hall
Cork

ISBN 0 9525 86940

cork rural design guide: building a new house in the countryside

**by Colin Buchanan and Partners Ltd
and Mike Shanahan + Associates, Architects**

Copyright in this publication vests in Colin Buchanan and Partners Limited, Mike Shanahan + Associates, Architects, and Cork County Council.

All rights reserved. No part of this document may be reproduced in any form (including by storage in any retrieval system), transmitted by any means, electronic, mechanical, photocopying, or otherwise, or adapted without the prior written permission of the authors and publishers.

Copyrights © 2003

Colin Buchanan and Partners Ltd
Mike Shanahan + Associates, Architects
Cork County Council

All sketches and illustrations (unless otherwise noted) by Mike Shanahan and Margaret Walsh, MSA Architects.

Graphic Design by Aoife Curran of Colin Buchanan and Partners Ltd.
Cover Design by H+A Visual Communication

Copyright of the worked example house and illustrations in the document are retained by Mike Shanahan + Associates, Architects

Copyright of the deep plan house in Appendix One is retained by Mary Kerrigan Frank Harkin Architects

Map images on pages 101 & 106 derived and reproduced from Ordnance Survey Ireland.
Copyright permit No. MP008903

Neither the authors (CBP or MSA) nor the publishers (CCC) are responsible for the consequences of the use of advice offered in this document by anyone to whom the document is supplied. Nor are they responsible for any errors, omissions or discrepancies in the information provided.



foreword

If you are thinking of buying a rural site, involved in selecting or designing a house for a particular site, or just interested in County Cork's heritage and future development, then this guide is for you.

The Guide is intended to make it easier to gain planning permission for those proposing to build, renovate or extend individual houses in rural County Cork. It does this by making clearer what Cork County Council and its planning officers and town architects are seeking, and explaining how choices about the site and the design can make all the difference to the success of a planning application and the completed house.

Other aims of the Guide are to

- stimulate debate about design;
- foster greater consistency in planning decision making;
- inform and inspire applicants, builders, designers and planners;
- and conserve and enhance the Cork landscape and environment.

This Guide does not cover matters such as whether a proposed house is permissible in a particular area of the County, or in what circumstances. For answers on these questions refer to the County (or Town) Development Plan and any Local Area Plan, or contact the Area Planner (or Town Architect). Neither is this Guide intended to specifically address housing development in villages and towns, or development other than houses in rural areas, though there is much in the Guide that may be of assistance to anyone undertaking such development.

It is unlikely that everyone would agree with all the examples and suggestions made in the Guide. Hopefully, people will think about and discuss how and why their views differ or agree with those in the Guide, and in this way the quality and profile of the debate will be raised.

It should be clear to anyone reading and looking at the examples in this Guide that the Council is not seeking to have all houses look the same. Rather, the Guide encourages the imaginative and radical as well as the tried and tested, provided they complement their surroundings. It does this by promoting an understanding of key design principles and the characteristics of Cork heritage and landscape.

Good design is not just a matter of taste. There are identifiable techniques and characteristics which will enable someone to make a house more efficient, more practical, and better related to its surroundings. This Guide provides an outline of these methods and considerations. If it can contribute to today's rural houses being regarded in the future as good places to live, and good things to look at, then it will have been a success.



contents

foreword	3
introduction	7
part one - careful site selection	12
part two - well considered site layout	26
part three - appropriate house design	52
part four- good construction	74
appendices	102
worked example	103
addressing the deep plan house	112
trees and shrubs	115
bibliography	117
photo & design credits	119
acknowledgements & accreditation	122



introduction

Few could argue that the countryside of Cork is one of the County's most valuable assets. It has an economic value, not just for its productive yield in the traditional industries of agriculture, forestry and fishing, but also for its very real value to the modern tourist industry. The latter is increasingly replacing the former as the anchor of the region's prosperity. A more obvious value lies simply in its scenic beauty, natural diversity and the pleasant, clean environment it provides for all of us to enjoy.

Cork County Council commissioned this guide in response to the pace of change now occurring across the County. Cork, just like the rest of Ireland, is currently experiencing an economic boom unlike any other in its history. Prosperity in the housing market has generated increasing pressure on rural parts of the County to absorb and provide for increasing levels of growth. More rural houses have been constructed since the boom of the mid-1990s than ever before in Cork's postfamine history. As the largest county in Ireland, with a substantial coastline of over 1,100 km, the challenge is to direct and manage this change to ensure that new housing development is in harmony with the outstanding environmental qualities of the County. These qualities include a very distinctive built heritage in rural architecture, a heritage as important to our cultural identity as our language, music and literature.

This guide is intended to assist applicants to gain planning permission for new homes by highlighting the key issues that should be addressed at an early stage in the house design process. It is aimed at all of those who are involved in the process of building a new house in rural Cork – the householder, designer, builder and planning officer. It is perhaps regrettable that there has been a general acceptance in recent times of extremely unimaginative standards of domestic 'rural' house design across the County. Responsibility for standards rests with each of these parties and in particular with those who prepare and submit plans on the public's behalf. What is important now is that this joint responsibility is recognised and that all parties make an effort to restore some direction to the evolution of modern domestic rural architecture in the County. Those most qualified to lead this change are the architectural profession, many of whom have generously contributed illustrations of their work to this document. Cork County Council and the authors strongly urge those seeking to build a new house in the countryside to consider the advantages of obtaining qualified architectural advice.

The guide does not purport to explain the Development Plan or the Building Regulations, and does not alter the need to have regard to that Plan and to comply with the Building Regulations.



approach

This guide will illustrate an approach to location that reflects the incredibly diverse landscape types that stretch across Ireland's largest county, from its uplands and agricultural hinterlands in the north to its busy coastline and island communities in the south and west. Advice on siting and layout will be dominated by the age-old considerations of shelter and blending with the landscape, with some practical thoughts on planning for privacy, play space, sewage treatment, access and respect for one's neighbours.

On the issue of design, the guide will on the one hand illustrate good, exciting, site specific contemporary houses which have been skilfully conceived and executed on appropriate sites (most often involving qualified architects), and on the other highlight the importance of simplicity, restraint, proportion and quality of materials. These are all key characteristics which make the architectural inheritance of Cork rural buildings so distinctive. Elements of Irish rural houses are examined and regional characteristics of the County explored. Some elements, such as windows, chimneys and doors need to be examined in detail, as these are all critical to successful rural design. However, the emphasis is not with the past but with the future. This guide aims to inspire the best in modern, contemporary Irish rural design. A design tradition that is Irish in origin; confident, assertive, artistic and a worthy contribution to Cork's future built heritage.

What does this guide aim to achieve?

- Better designed houses for people to live in;
- Better located houses to look after the appearance of the countryside;
- More thoughtful siting of houses to make them warmer and more comfortable places to live;
- Cheaper and more efficient houses to heat in the future through the use of energy saving technologies and renewable sources of energy in accordance with insulation requirements of the Building Regulations;
- The promotion of contemporary Irish design and the regional characteristics of Cork architecture;
- An easier understanding of how to gain planning permission by making better applications, with well-designed houses on carefully selected sites.



8



9



10



11



12

this guide will emphasise:

Stewardship/Guardianship - Each one of us has a responsibility as steward of the countryside not just to preserve heritage, but to create a heritage for the enjoyment of future generations. The building of a new house in the countryside should be a positive addition to the rural environment and not appear incongruous with, or detract from, its surroundings.

A Sense of Place and Community - Much of the character and quality of the Cork countryside derives from the range of traditional buildings and their use of local materials. These buildings are part of Cork's heritage and regional identity. Whilst not advocating an imitation of the past, new buildings should reflect the dynamics of their location, the availability of local materials and the built character of what has gone before.

Contemporary Rural Living and Lifestyles - Adaptation to modern living and lifestyles must be an essential component of any new design. This guide aims to offer a more exciting and sympathetic alternative to the suburban style of many new rural homes.

The Long Term - A new dwelling permanently alters the landscape, therefore a new building needs to be designed and constructed with a view to the long term implications of its impact on its surroundings. Buildings should be durable, capable of future adaptation, and integrate fully with the local landscape.

Innovation and Quality - Striking a balance between prescription and innovation, tradition and contemporary is not always an easy task. Good design respects and learns from what has gone before and interprets traditional forms and materials in the contemporary context. Innovative design is a welcome addition to the rural countryside, but only if expertly and sensitively handled.

Affordability - Good design does not equate to expensive design. It is just as possible to have a well-designed affordable home in a rural landscape, as it is to have a badly designed costly dwelling. This guide recognises that not all applicants wishing to build in a rural locality can afford to pay a designer. However by sticking to the general rules of simplicity and modesty it is possible to construct a well-designed, affordable "dream home".

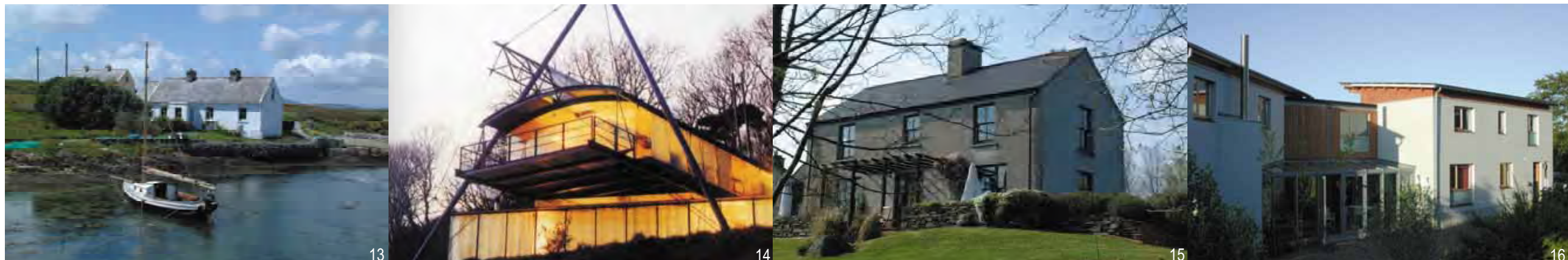



good planning & design

This guide is laid out to take you through the following considerations when preparing to submit a planning application. These considerations are not sequential but need to be addressed in parallel to produce the most favourable outcome. Each aspect is designed to assist you to submit a successful proposal for a new house in the Cork countryside. These considerations are summarised in the following key points:



careful site selection Check location issues in the County Development Plan. Seek out good 'Natural Sites', which will reduce the impact of new houses. Choose sites offering shelter, privacy and good orientation, i.e. allow more extensive south-facing glazing unseen from neighbouring roads, with existing features if possible. Recognise that prominent or sensitive sites will require more care and skilful handling. Avoid sites that will entail removal of attractive roadside hedgerows, trees, etc.



well considered site layout Address prominence, shelter, passive solar gain, privacy and impact issues with various house locations, types and orientations before finalising site selection or house design. Maximise the benefit of existing site features. Ensure the house appears to sit down into the site. Address functional engineering issues in parallel, such as safe access, drainage, etc. Reduce the openness of the site by breaking it down into different areas. Locate cars out of sight. Minimise green baize lawn areas.



appropriate house design The site and the development of a good layout should inform the shape and height of a new house. Keep the shape of the house very simple. Minimise modelling of the 'front' facade. Develop the house design to incorporate attributes of rural houses of the area, paying particular attention to good proportioning. Cork rural houses tend to be deceptively simple and well-mannered. Always ask if the house proposed is appropriate to the site context, if not seek an alternative site or different house design. Be aware that larger houses need large sites and/or massing needs to be simply broken down.



landscape design In parallel with site and house design, the landscape 'design' of the site should endeavour to link the new house with the countryside around it. House, garden and landscape must be designed as a unit if the house is to achieve a strong link to the land. Differing types of countryside will result in different appropriate responses to the landscape. Aim to achieve naturalistic planting effects using predominately indigenous/local species and groupings. Buffer the house from the road or public view to reduce impact and leave the existing roadside/ hedgerow/ boundary intact wherever possible. Make areas for plants to grow against the new house. Minimise the extent of mown lawn areas.



good construction 'The devil is in the detail'. Traditional detailing gives many clues as to how new houses can settle more happily with older neighbouring houses, irrespective of style. Irish rural houses traditionally rely solely on attractive proportioning, careful use of colour and quality of materials for their success. More often there was substance to what was built. For example houses near the coast look as if they were built for hurricane climates with minimal eaves and verge, etc. Avoid white plastic and 'add-on frills' wherever possible.

A checklist is provided at the end of each section to alert you to potential problems and to guide you along. The worked example at the end shows you exactly what the planner will need in order to consider and assess your application.

It is important to note that, in all instances, your building must comply with current Building Regulations.

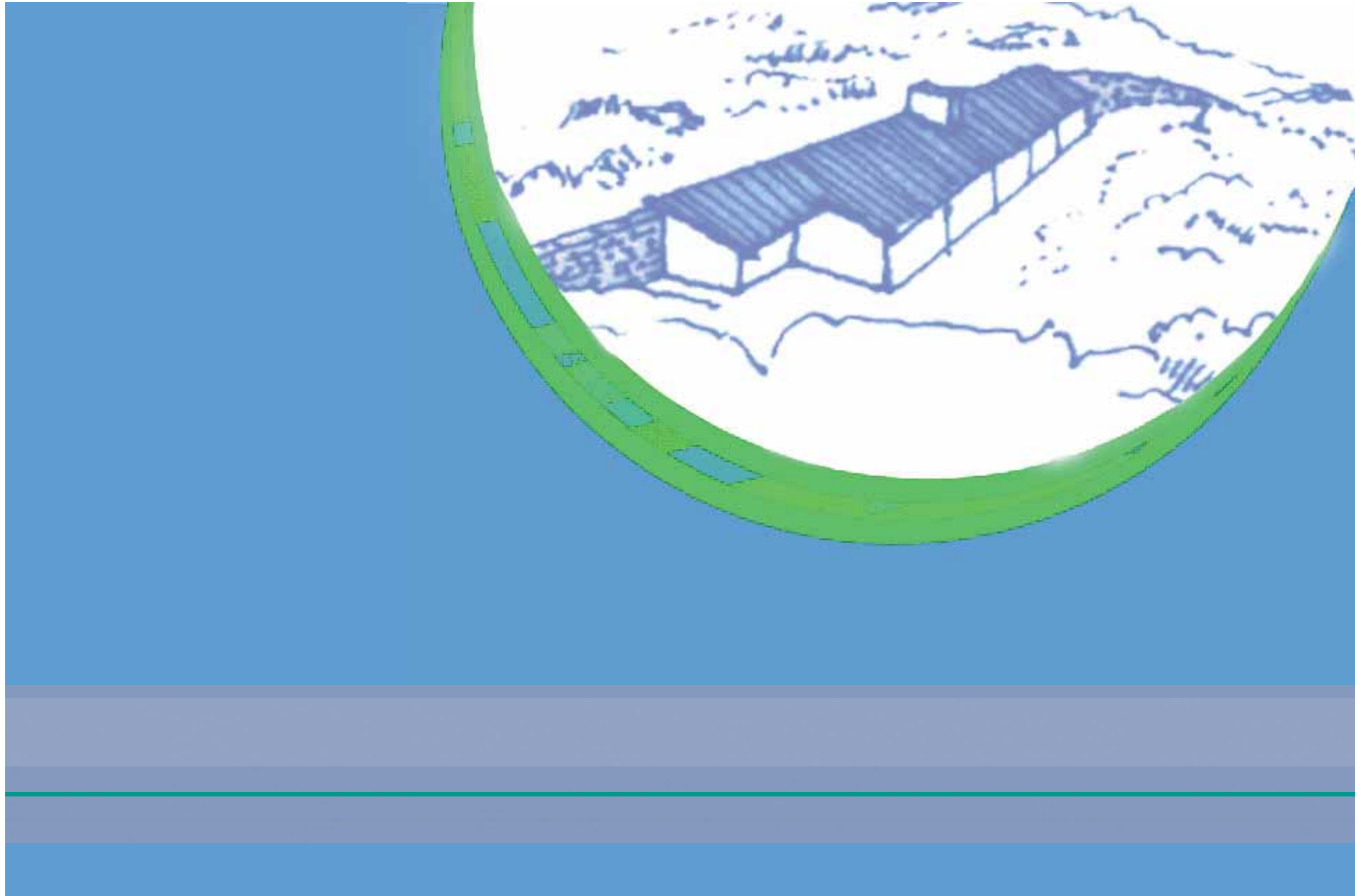

part one

site selection

- Check the development plan
- Reading the landscape
- Choosing where to build
- Assessing a site's potential
- Linking with the land
- Summary & Checklist



site selection

The successful siting of a new house in the countryside requires care and consideration. It should involve an analysis of the impact the house will have on the appearance of the land, the impact it will have on the comfort of its occupants, together with practical considerations of connecting to power, water and roads. The landscapes of the County differ so much that the response to location will reflect local circumstances and local settlement patterns. This section helps you to identify landscape characteristics and gives advice on how you can work with these characteristics to integrate your new home into the very fabric of the countryside.

A well sited house will save you money because it will be well sheltered, retain more heat and use less energy

The aim is to ensure that new development appears visually integrated and sympathetic with its surrounding landscape rather than imposed upon it.

A dwelling badly sited will alter the character and appearance of the landscape, often setting a poor precedent for future development to follow. However, **where siting is carefully considered**, it is possible to construct a dwelling that not only contributes to the character of the landscape but which sets high standards in terms of siting, location, and design, and which both respects and reflects local traditions. It will be oriented to face south for warmth, and be landscaped to provide shelter from the prevailing wind and be situated to provide privacy from the road.



19

When choosing a site check the Cork County Development Plan, and any Local Area Plan for the locality, in particular for:

- Policies restricting/permitting development in certain areas eg. Greenbelt, Coastal Areas, Rural Housing Control Zone etc
- Scenic Amenity Maps - scenic routes and scenic landscapes;
- Heritage maps - Natural Heritage Areas (NHA), Special Protection Areas (SPA) and candidate Special Area of Conservation (SAC) and Areas of Geological Interest;
- Landscape Character Maps;
- Archaeology policies, the Record of Protected Structures and conservation policies.

If your site falls within any of these areas take advice from the Council Planning Department before proceeding.

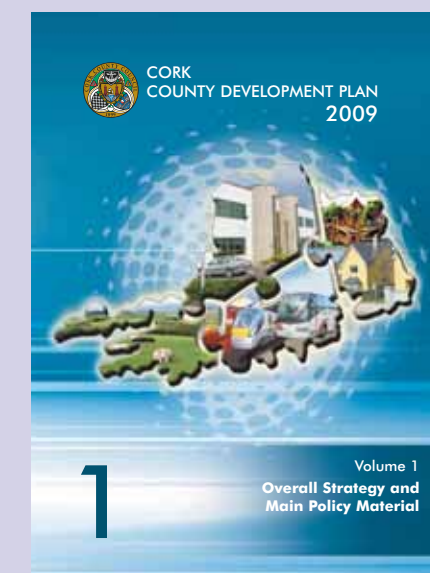

reading the landscape

Mountains

- Derrynasaggart
- Ballyhoura
- Nagles

Fertile Plain of Blackwater Valley

- Banteer
- Mallow
- Fermoy

Fissured Marginal and Forested Rolling Upland

- Boggeragh
- Mullaghareirk

River and Reservoir Valleys

- Inishcarra
- Coachford
- Macroom

Ridged, Peaked & Forested Upland

- Inchigeelagh
- Millstreet

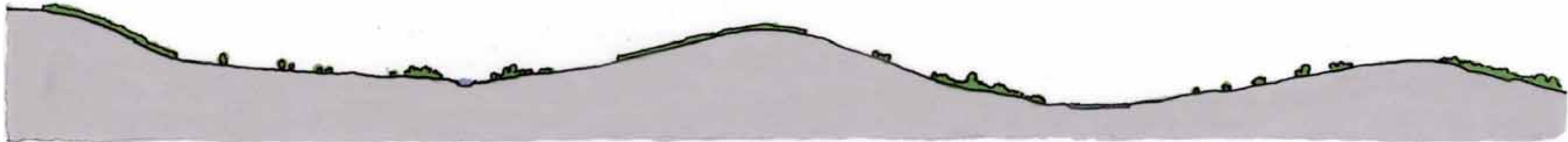

As the largest county in Ireland, the landscapes we have in Cork vary greatly. It is a rich and diverse landscape. Landscape types range from the rolling hills, valleys and scrub of the farmland and moorlands of north Cork, through the low-lying flatlands, rivers and lakes of the central area, to the uplands and valleys of the east. This contrasts with the rocky and rugged ridges and peninsulas to the west, particularly along the Beara peninsula, and the patchwork of fertile coastline mixed with estuarine mudflats along the southern coastal region. Also, one must not forget the multitude of islands off the west coast of the County, with their myriad stone walls marking out field boundaries.

Geologically the County is comprised of two rock types: predominantly old red sandstone, with a smattering of carboniferous limestone more dominant in the south and east, both of which influence the raw materials used for construction. Each of these landscapes require different considerations, particularly when selecting a site for a building platform. A regional variation in housing design occurs within the County, related to the East/West regional variation throughout Ireland. Variations in regional housing design were a direct response to the local environment.

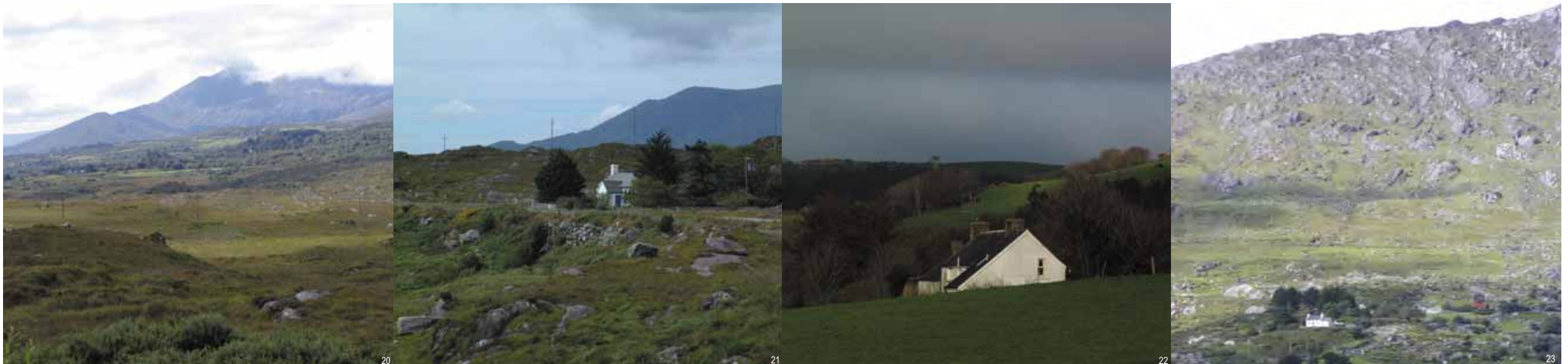

Lowland Valleys

- Dunmanway
- Bandon Valley
- Drimoleague
- Castlemartyr
- Bride Valley

Indented Estuarine Coast & Broad Bay Coast

- South Cork* Robert's Head
Oyster Haven
Kinsale harbour
- West Cork* Courtmacsherry
Clonakilty

- East Cork* Youghal
Ballycotton
Cork Harbour

Headlands - West Cork

- Beara Peninsula
- Sheeps Head
- Mizen Head
- Kinsale Head
- Galley Head
- Myross

Coastal Islands

- Whiddy
- Horse
- Hare
- Sherkin

Coastal Islands

- Dursey
- Long
- Bear
- Clear (Oilean Cleire)



Throughout the County, buildings were orientated to make best use of shelter and sun, using natural features such as the lie of the land combined with hedgerows and shelterbelts to best protect them from the elements. Small farm holdings and clachans were more common in the west of the County, as was the long house.

The coastal islands, most of which lie off the west or southwest coastline, were more exposed and therefore dwellings tended to be single storey with west-facing gable ends for shelter. These included Congested Districts Board housing such as rural labourers' cottages, and were essentially improved versions of traditional dwellings, perpetuating the lobby entrance but replacing the hipped roofs with gables and the thatch with slates. Almost all of the houses on Long Island, southwest Cork, were rebuilt by the Congested Districts Board, using two-storeyed farmhouses and small houses with attic bedrooms. In the north and east of the County, with its rolling hills and valleys, the hipped roof was more prevalent. Walls were traditionally mud and stone and roofs were often thatched, reflecting the agricultural nature of settlement. From the 19th century slate replaced thatch as the dominant roof material. Corrugated iron was also used to replace thatch.



choosing where to build



Having considered the nature of the landscape in which we want to build, we then need to choose where in that landscape it is best to locate a new house. Two factors should dominate this decision - shelter and orientation towards the sun. Some sites require different responses to others. Less sensitive sites can take much more individualistic houses, whereas more prominent or sensitive sites require greater skill and care.

A great deal can be learnt from observation of traditional methods of site layout, which appear more integrated within the landscape. These involve making use of natural tucks in the landscape, sheltered areas beside woodland, working with gradients and not against them, and generally choosing locations which avoid the worst effects of the wind and the rain. Distance to local facilities should be a critical factor in selecting a site. Try to choose a site that is close to work, school and shops etc. to avoid the need to travel too far for daily journeys

avoid exposure & prominence

- Study the alignment and orientation of older houses in the area e.g. the traditional alignment of houses - gable to wind/west to maximise shelter and reduce exposure

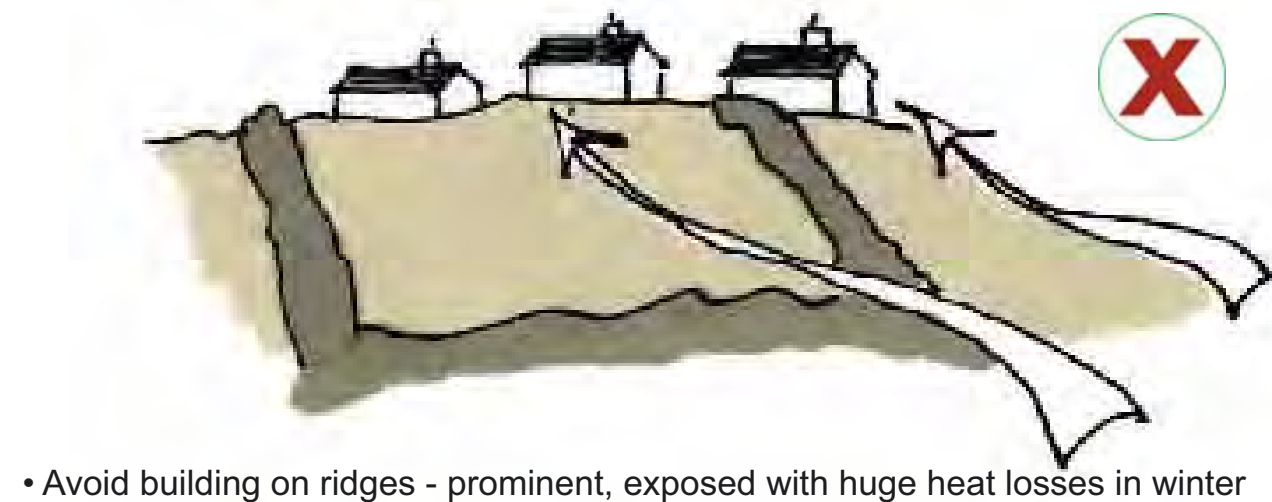
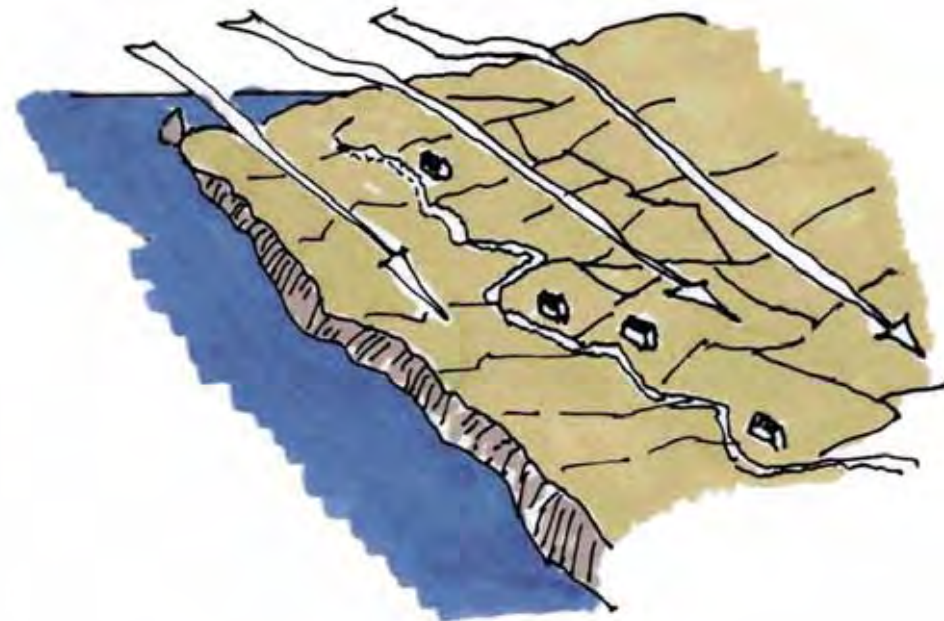

seek shelter & integration ...use natural elements to your advantage

- Where possible use the natural backdrop of trees/ shelter belt. **Note:** deciduous planting to the south will give summer shade and winter light



• Huddle of buildings in lee of knoll

• House sited in a hollow using the hillside for shelter



• House built in a 'tuck' on a headland



• Inland sites using tree cover

• Coastal-clustering clachan



assessing a site's potential...a possible good site and three responses

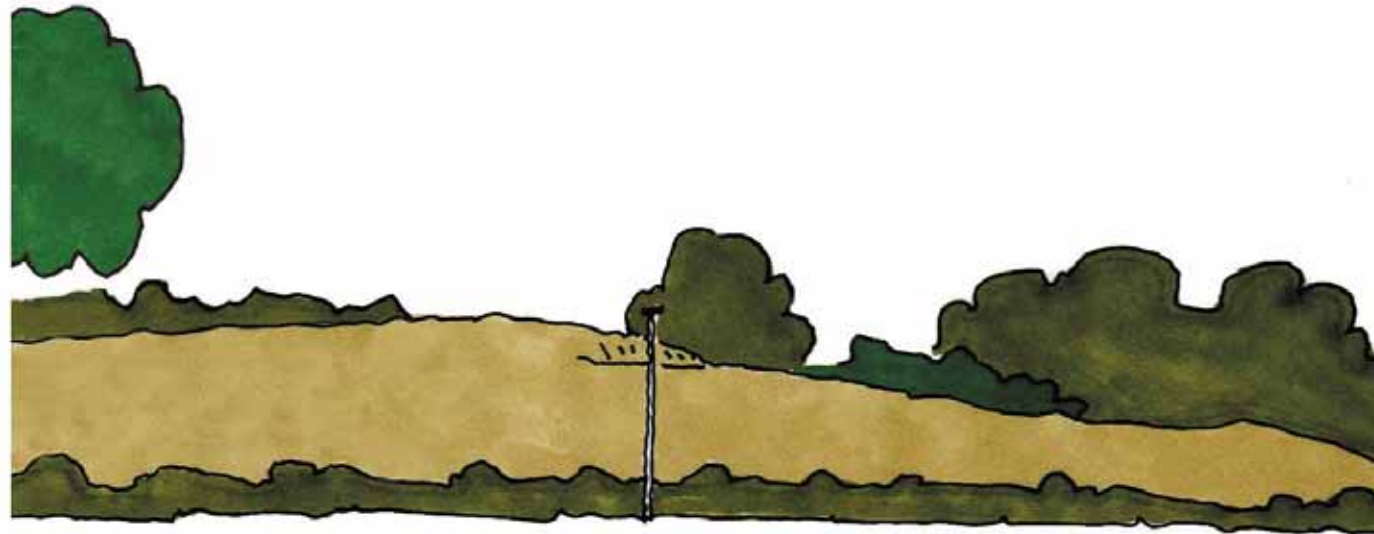

Corner of a Farm Holding

The site is sloping southwards, has trees as a backdrop, shelter from the hillside, hedgerows to the front and easy access to services at the roadside.

This exercise aims to illustrate how an applicant buying a site, or a farmer selling a site, might consider some typical responses which often create planning difficulties. By looking at the same piece of land with a slight change in approach in site layout and house design we can achieve a much more satisfactory result.

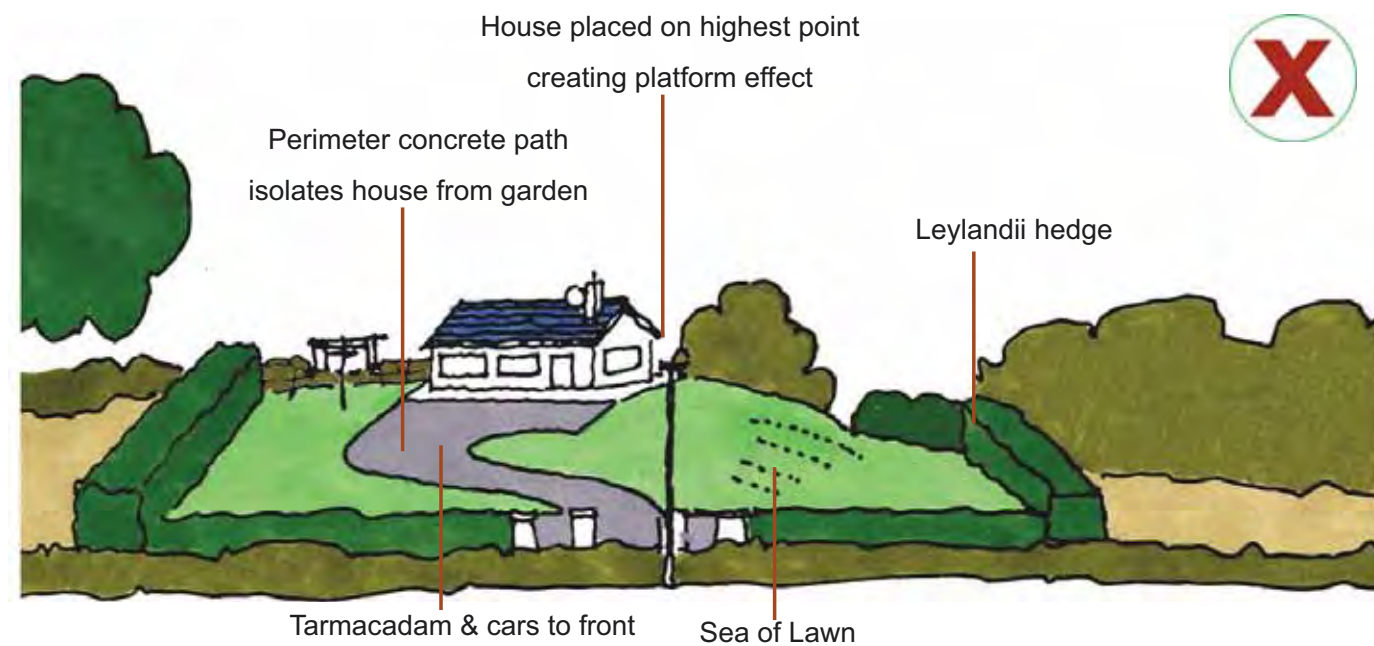

The 'Drop-in' Bungalow

A typical response of the 70s & 80s to avoid

- House positioned on the most elevated and exposed part of the site
- Pattern book bungalow isolated from the landscape by concrete path and manicured garden
- Suburban treatment of house and garden with no use of 'natural' landscaping
- Hedgerows removed and replaced with Leylandii hedging
- Lack of enclosure
- Absence of privacy
- Cars to the front

The 90s Approach

Big house too close to road, full impact presentation

- House positioned to be seen. Large in scale, dominant within the local landscape
- No shelter or link with the landscape - exposed and buffered by the weather, no enclosure or privacy to the garden areas
- Sea of green lawn and tarmac, cars to the front
- Poor use of materials and detailing, lots of plastic and imitation stone facings
- A platform has to be cut and/or built up because the footprint of the house does not relate to the contours of the land.

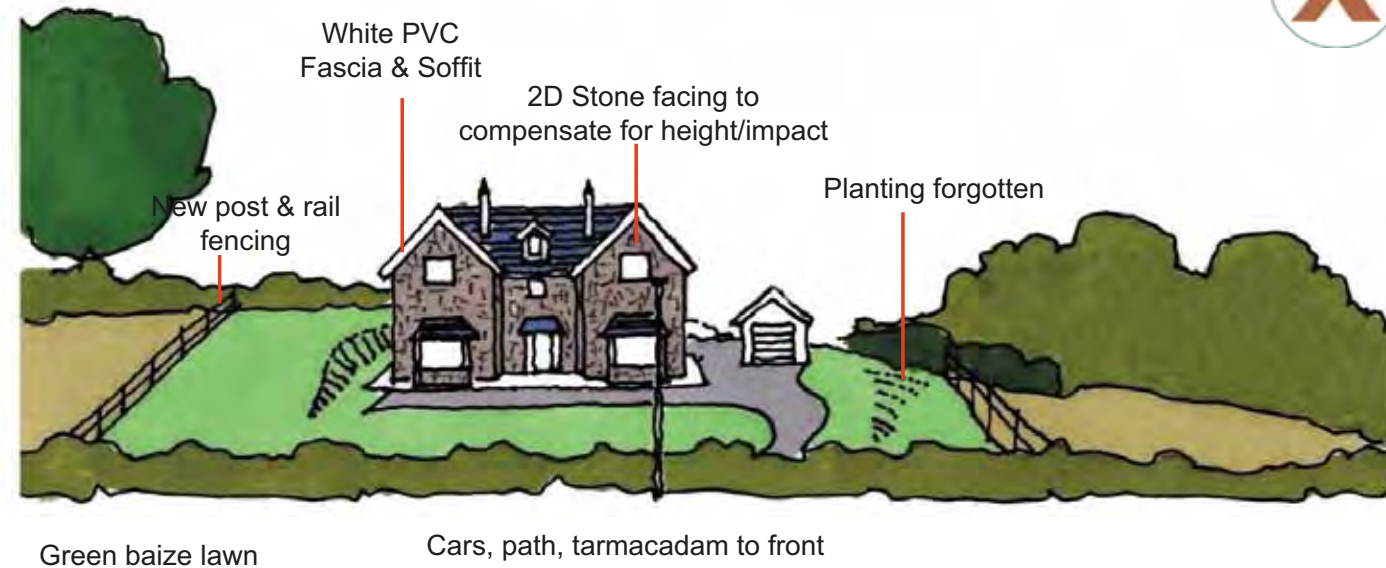

The All-Show Clunky House

Rural Cork 2000s

Rural type house & site layout, links it with countryside & neighbours

- Most sheltered part of the site selected
- House orientated to maximise daylight and solar gain
- House set down into landscape and well linked to it
- Set back from the road and retaining the frontage hedgerows
- The massing of the house is broken down and follows the contour of the hills without the need for a platform
- Garden areas are secluded and private
- Modern comfortable home that blends with its setting

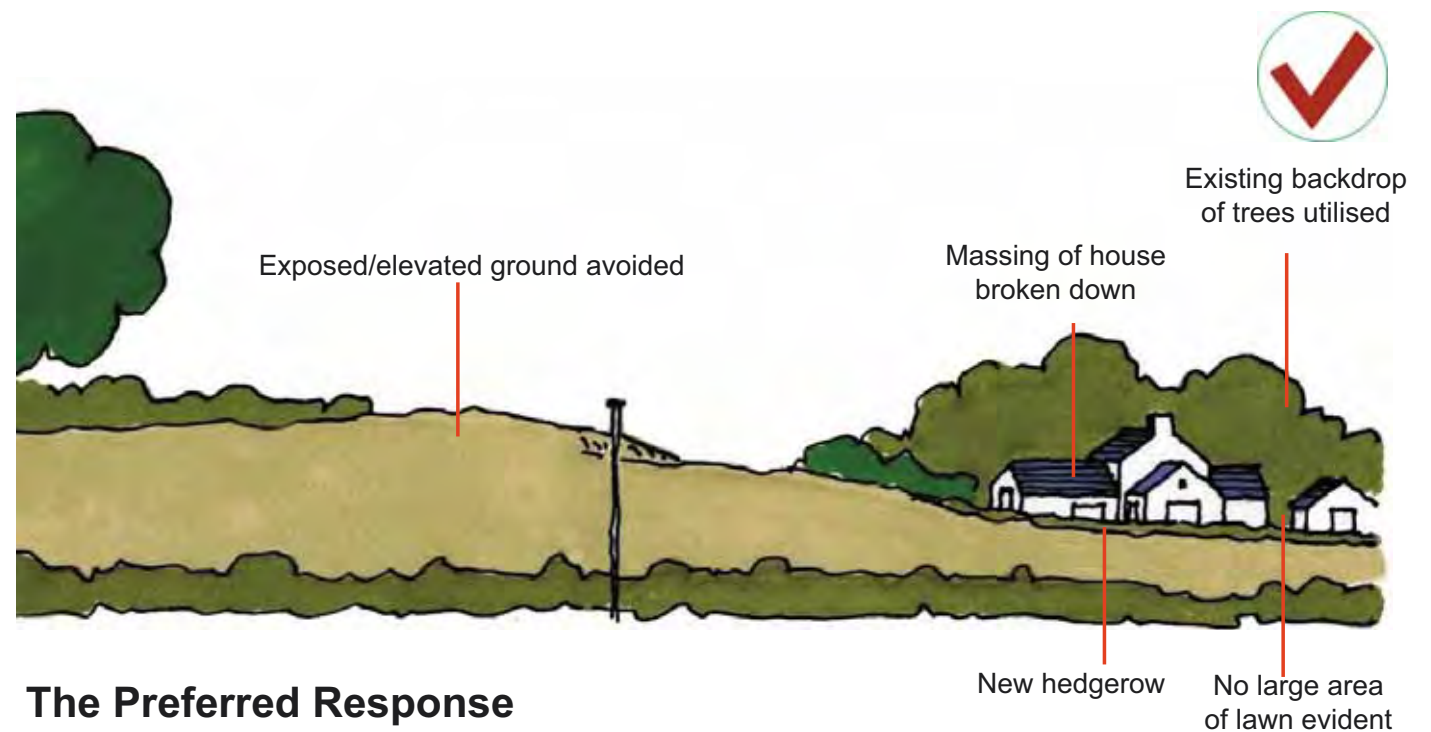

The Preferred Response

linking with the land

A good site, from a planning viewpoint, might be defined as one which easily allows a new house to settle into and integrate with its surroundings. Too many new houses appear as if they've been lifted from a town suburb and simply placed on top of a rocky hillside. The secret is to work with the landscape and not against it. Keep as many hedgerows, trees, and stone walls as you can. Place the driveway to the side or rear. Keep expansive green lawns under control and plant the garden close to the house.

- Leave existing roadside hedgerows and ditches intact as much as possible;
- Avoid car parking to the 'front' of the house, i.e. between the house and the road. This will often mean making entrance courtyards or locating the 'front door' to the side or rear of the house, as seen from the road;
- Use contours of original site to soften the setting of the house;
- Try to retain at least two, preferably three, existing boundaries (either natural hedgerows or stone walls) to soften visual impact of the house;
- Pull paths a couple of feet away from the house to allow zone for planting contact with the house;
- Allow the garden to run up to/meet with the house in places, greatly enhancing its connection with the site. Avoid encircling house fully with paths;
- Use hedges, walls and planting close to the house to reduce its impact and assist in connecting it with its site;
- Plant and/or contour the site where necessary to maximise sheltering the house;
- Reduce/minimise the hard landscape zone about the house, isolating it from the garden which reinforces a 'platform' effect;
- Avoid isolating a house on a platform on the site surrounded by a sea of mown lawn;
- Use materials of the locality, e.g. stone and pea gravel from nearby quarries, etc. Avoid black tarmacadam driveways, brick 'features' which are out of context, or manufactured looking materials, such as some pre-cast concrete products;
- Avoid asphalt finishes and decorative lamps illuminating driveways as these are not suited to rural locations.



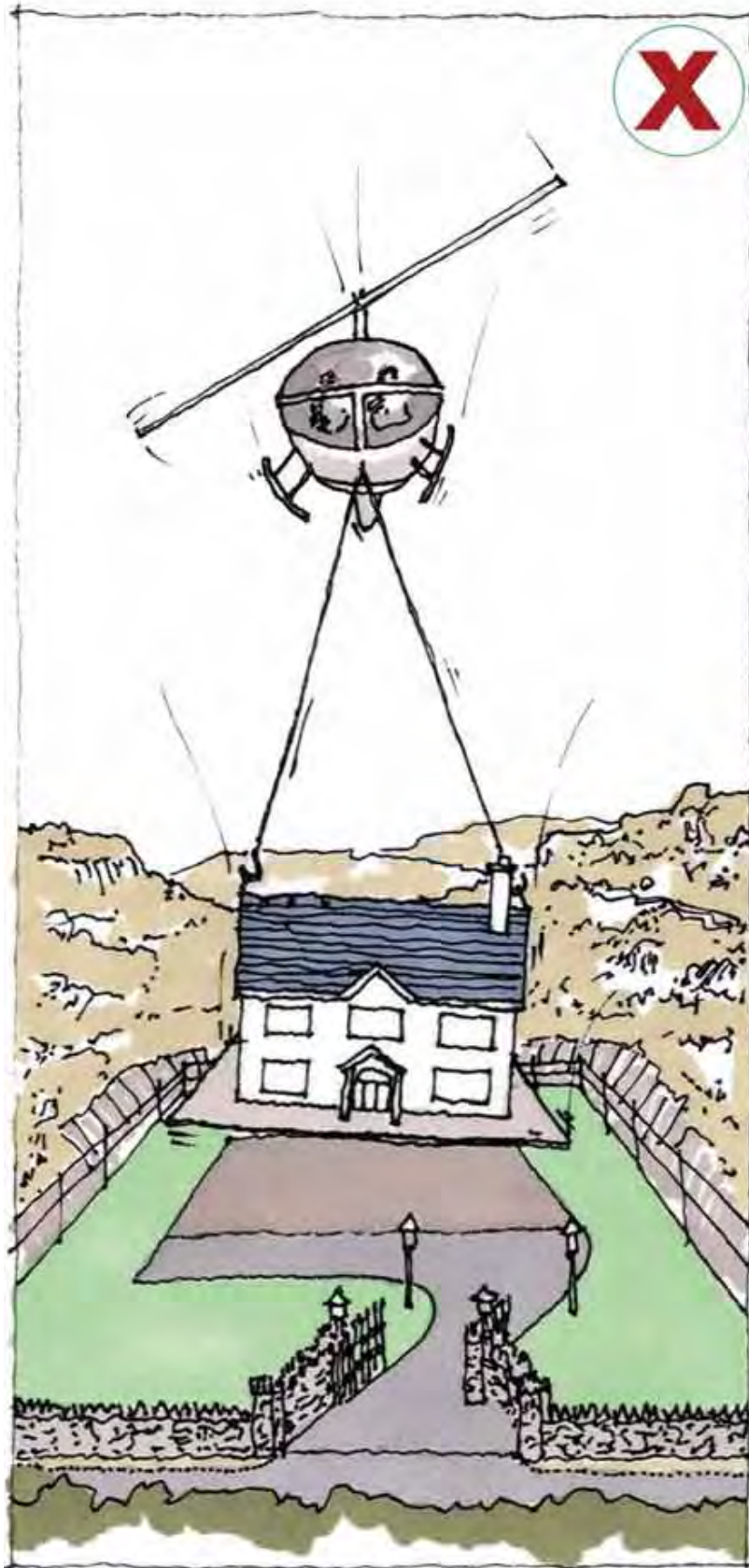

Alien 'Helicopter Drop-in' effect to house + site

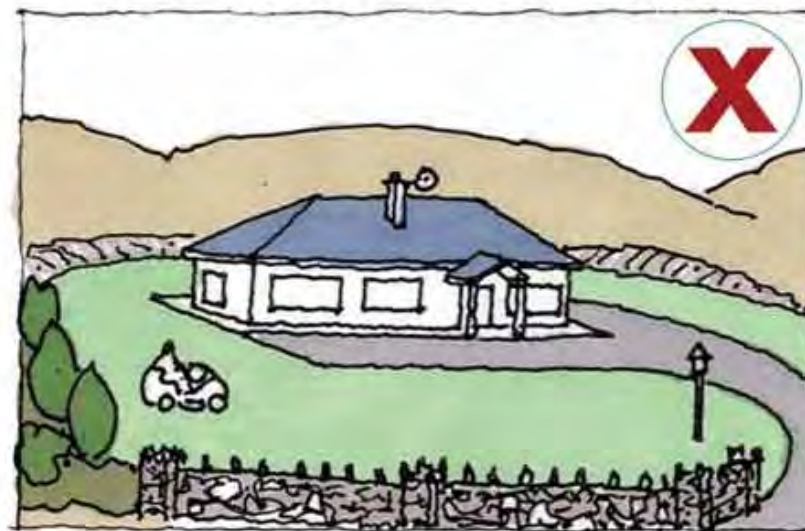

House isolated, cars to front, sea of lawn

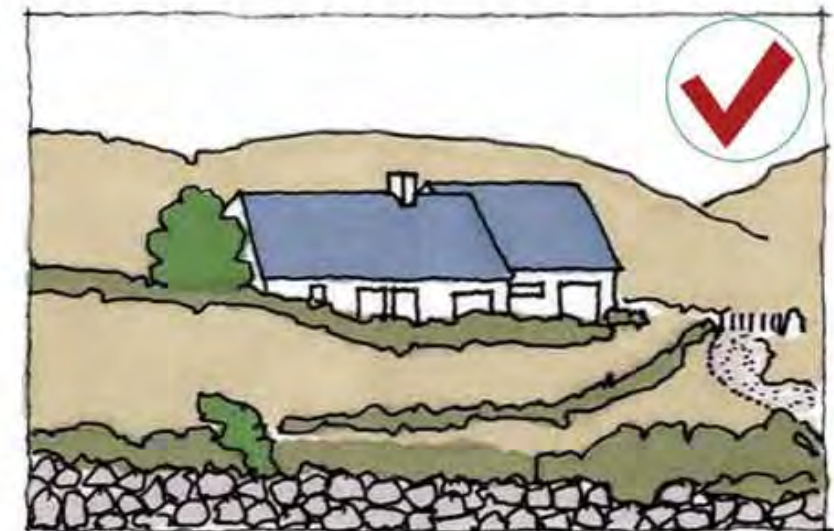

Attractive roadside wall, contouring, natural enclosure

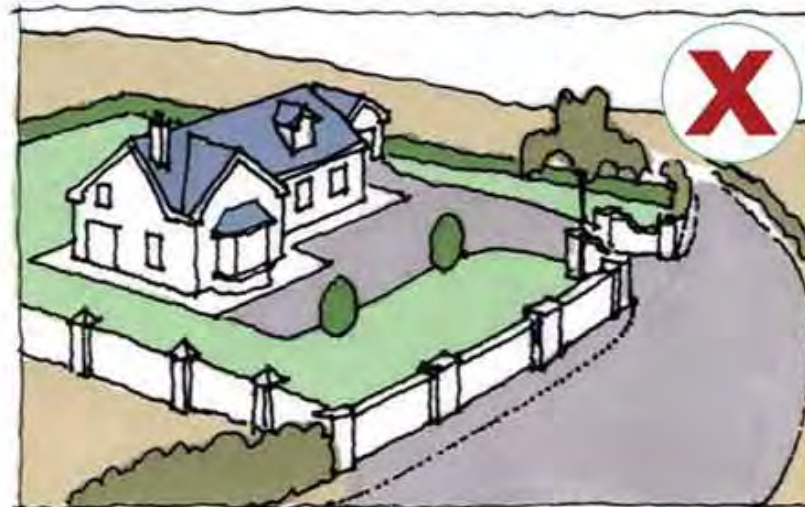

House isolated, urban boundaries, no buffering

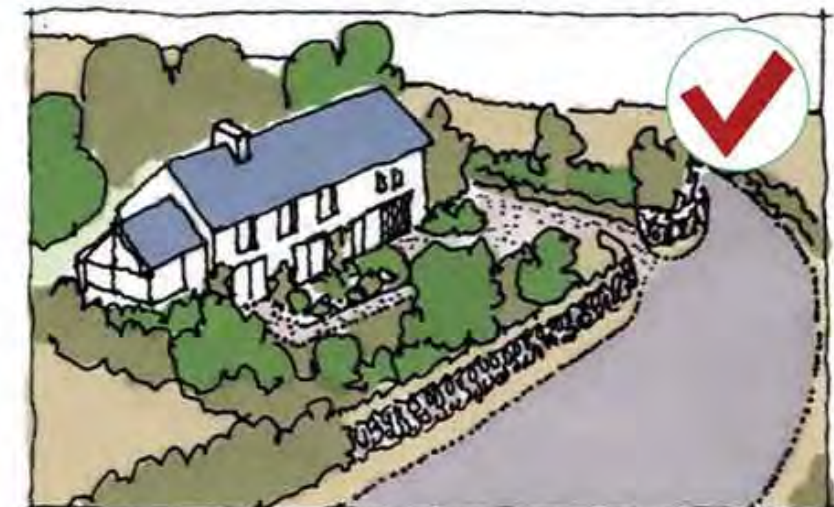

Rural road and wall, no concrete path, house anchored

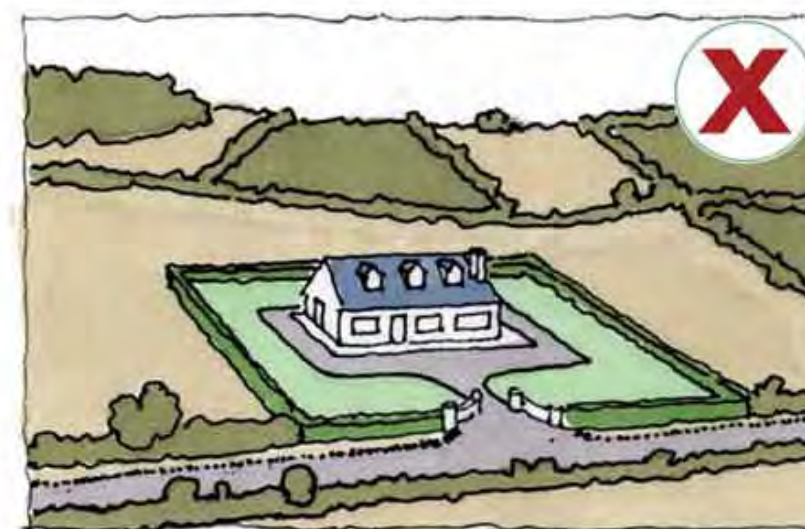

House isolated from site, site isolated from the landscape



House + site linked to countryside



summary & checklist

site selection

have you?

Described the important characteristics of the site?

Found a site in the optimum location in terms of visual impact - i.e avoided a prominent position?

Found a site that provides shelter from prevailing winds and landscaping - i.e. avoided the ridge line and found a site with a natural back drop?

Found a site with the appropriate aspect to maximise the sunlight?

Found a site where at least two but preferably three existing natural boundaries can be retained (e.g. existing hedgerows, walls or woodland)?

Found a site that allows safe access without removal of roadside boundaries?

Created privacy for the proposed dwelling?

Assessed alternative sites for their suitability?

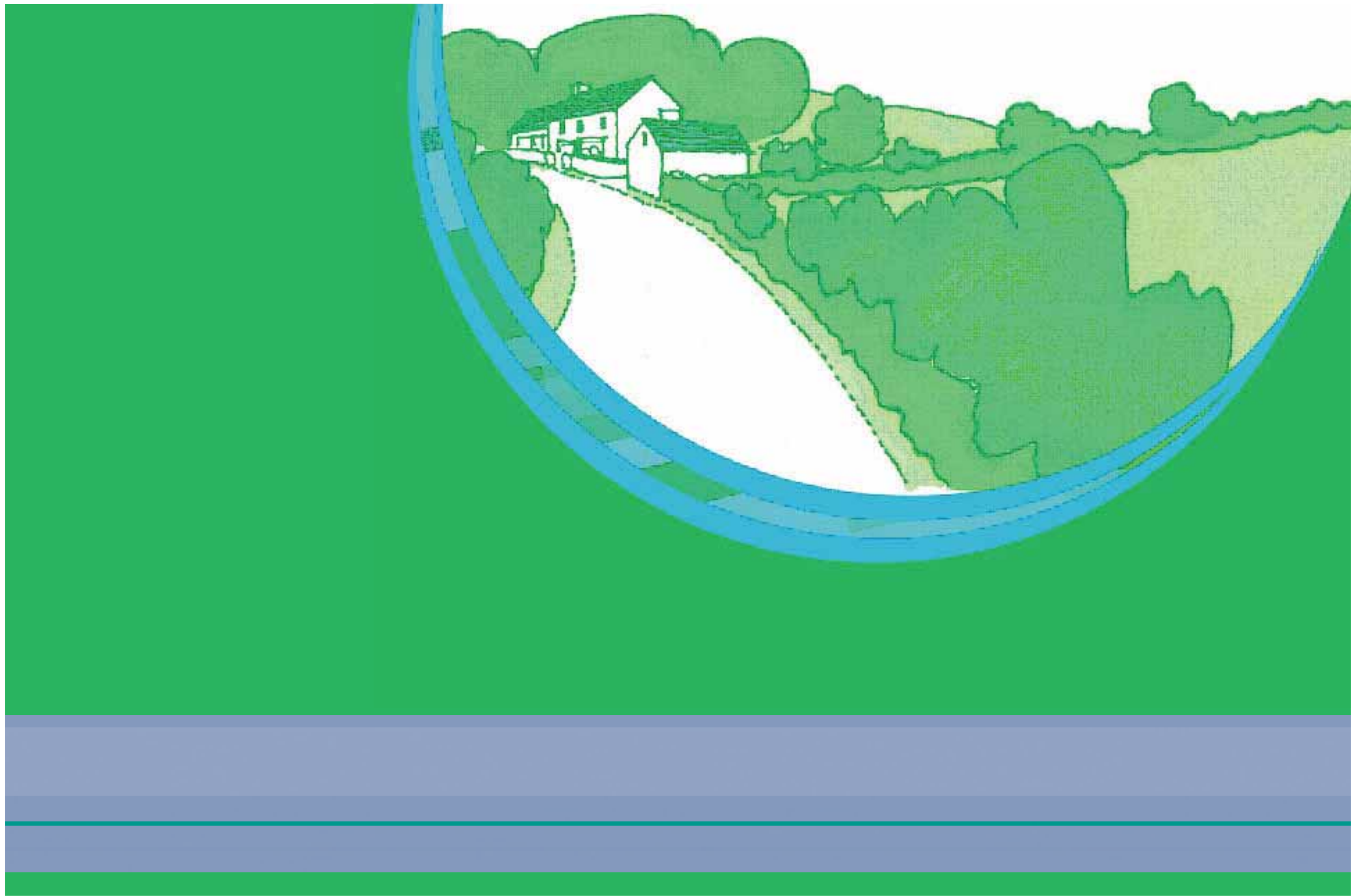

part two

well considered site layout

- 20 things every house should consider
- Orientation and mapping the sunpath
- Study the options
- Dealing with contours
- Garden design
- Creating new boundaries
- New planting
- Making an entrance
- Summary & Checklist



37

site layout

The purpose of this section is to illustrate that by observing traditional principles and some common sense, we can achieve development that is more sympathetic and integrated into the surrounding landscape. This will ultimately enhance the energy performance of the dwelling making it cheaper to run and more comfortable to live in. The principles contained within this section should be considered in conjunction with the principles of site selection:

- Take advantage of natural light and heat
- Orientate the dwelling to reduce exposure to the wind
- Consider new site and boundary treatment carefully
- Identify the wind direction and sun path throughout the year
- Design to link with the landscape

● *Examples of site layout designed as a direct response to the existing contours and natural features*

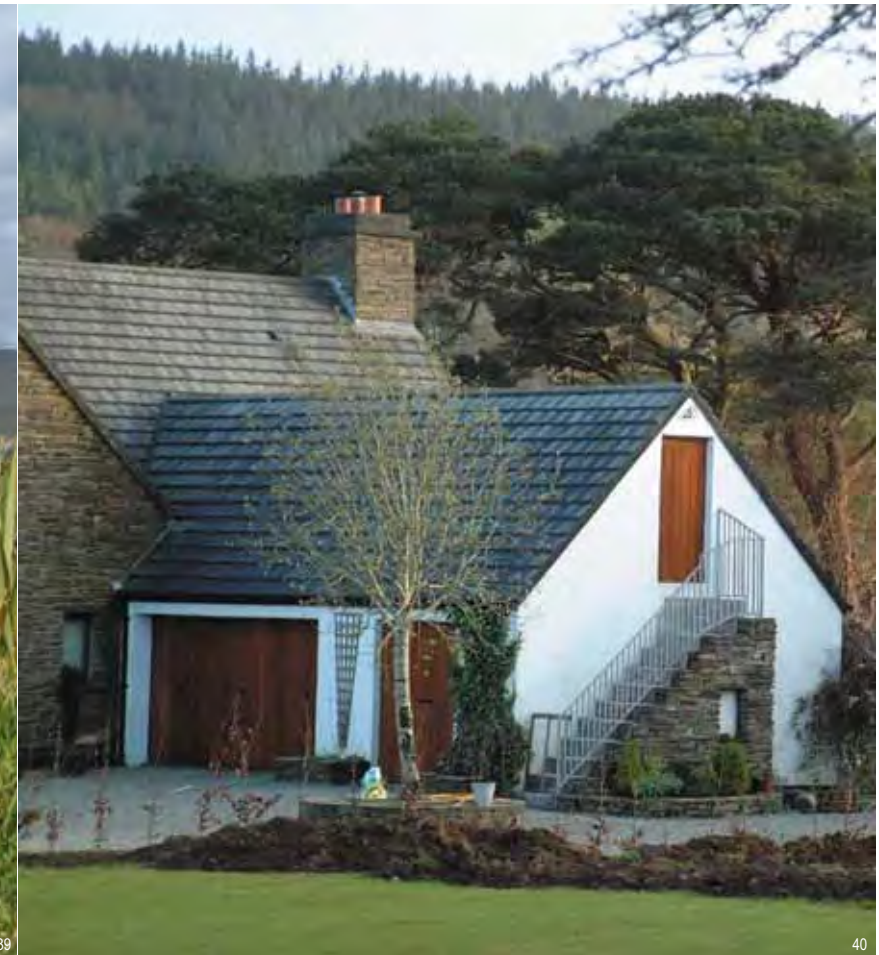

20 things a rural house should consider...

The proper planning of a modern rural home requires that thought be given to a broad range of items. Too often only the practical servicing items get attention and the rest are ignored. Yet we need garden and amenity areas effectively screened from the road where we can enjoy our home and allow our children to play safely, as well as work and refuse areas that are well hidden from public view. Energy efficiency and environmental concerns need to play a greater role in the design and layout of our homes. There is a link between the desirability of reducing CO2 emissions and the demands of, for instance, the role of parents as a 'taxi' service for their children's school and other activities. Distance to local services must therefore be a critical factor when planning the construction of a new home. Try to choose a site that is close to work, the shops and where the children go to school, to avoid the need to travel too far for daily journeys. Also try to strike a balance between shelter from the wind and exposure to the sun. By simply orientating the house to maximise solar gain it is possible to reduce fuel consumption and create a brighter home.

When the 20 things illustrated on the facing page are not given thorough consideration, the result, as illustrated below, left gives rise to an impoverished layout with no screening, privacy or shelter. Alternatively, if issues are thought about at the outset they will influence the type of site selected and lead to a much improved proposal, as illustrated below right. The following section of this guide will take you through the factors that should be considered when designing a rural home.



- 1 Local facilities ✓
- 2 Prominence ✗
- 3 Energy ✗
- 4 Sun ✗
- 5 Shelter ✗
- 6 Access ✓
- 7 Power ✓
- 8 Water ✓
- 9 Telecoms ✓
- 10 Drainage ✓
- 11 Fuel /Storage ✗
- 12 Refuse ✗
- 13 Work Area ✗
- 14 Recycling ✗
- 15 TV & Satellite ✓
- 16 Parking ✓
- 17 Privacy ✗
- 18 Safety ✗
- 19 Clothes/ Line ✗
- 20 Garden Amenity ✗

8/20 - Poor solution



- 1 Local facilities ✓
- 2 Prominence ✓
- 3 Energy ✓
- 4 Sun ✓
- 5 Shelter ✓
- 6 Access ✓
- 7 Power ✓
- 8 Water ✓
- 9 Telecoms ✓
- 10 Drainage ✓
- 11 Fuel /Storage ✓
- 12 Refuse ✓
- 13 Work Area ✓
- 14 Recycling ✓
- 15 TV & Satellite ✓
- 16 Parking ✓
- 17 Privacy ✓
- 18 Safety ✓
- 19 Clothes/Line ✓
- 20 Garden Amenity ✓

20/20 - Successful integration



Distance to local services



Prominence/Impact



Energy Conservation

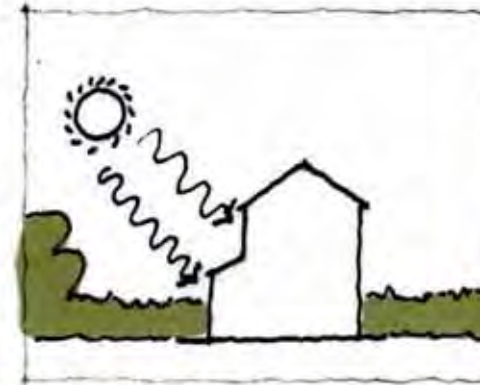

Sun



Shelter



Safe access

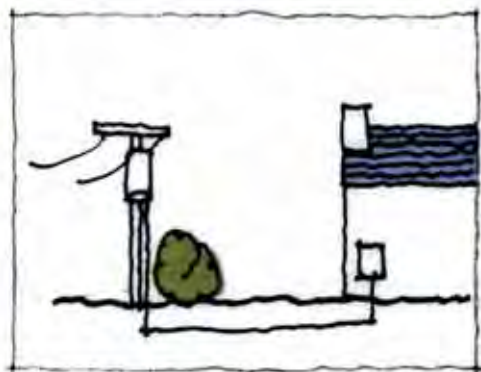

Power



Water

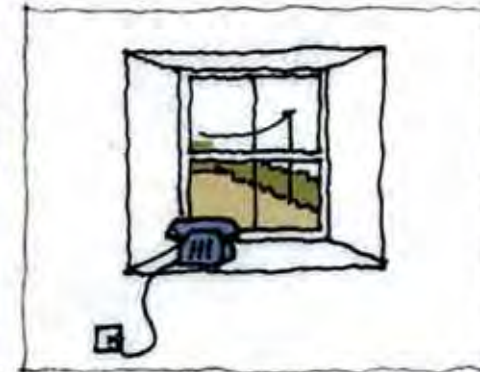

Telecommunications



Drainage

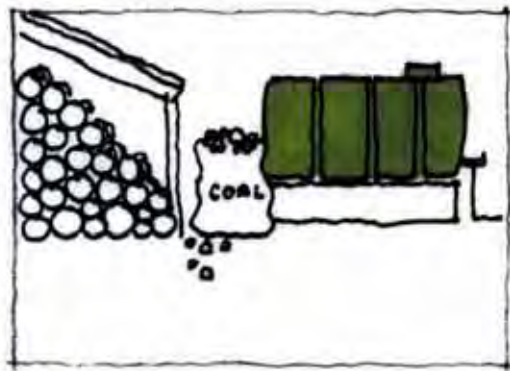

Fuel Storage Area



Refuse storage area



Tools/work area



Recycling area

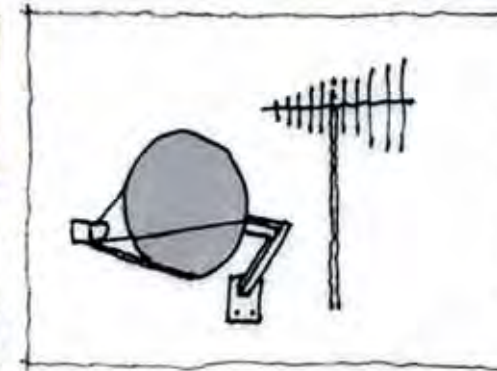

T.V. Receivers



Cars turning/parking



Privacy



Safe kids play area

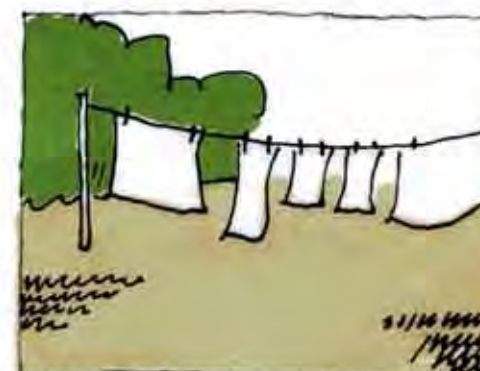

Clothes drying area



Garden amenity areas/veg etc.

orientation ... capture the sun's free energy



Examine the site's exposure to the natural elements, particularly the sun and prevailing winds. By identifying the wind direction and sun's path throughout the year, the dwelling can be orientated to reduce exposure to the wind and take advantage of a natural source of light and heat - maximising from passive solar gain. This will significantly improve the energy performance of the dwelling. A good site layout is one that successfully manages to resolve the often conflicting considerations affecting on the way a house should be orientated - views, the sun, shelter, privacy, minimising impact and so on

- Consider the best vantage points from the established sheltered positions to maximise views and prospects from the dwelling so that the orientation of the dwelling can then be determined - sometimes it may be necessary to rotate a house on the site so that its impact can be minimised. Also note that it is possible to capture a view without orientating the whole house towards it, e.g. by placing windows in gable ends
- Be careful in managing the conflict between privacy and glazed frontages facing the road



Highly glazed south elevations present problems where they are seen from the road

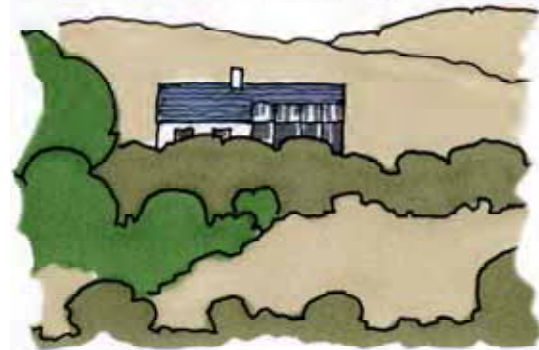

Highly glazed south elevations possible where topography or substantial existing tree cover offers screening



Appropriate solid looking appearance achieved by selecting site with northerly presentation to road

• Use of glazed walls to maximise natural light and heat - most suited to private rear elevations

• Carefully sited eco-house near Bandon (Photo 43) - designed entirely to maximise solar gain and be energy efficient. Not suited to every location but well sited here within 1 hectare of woodland



map the sunpath

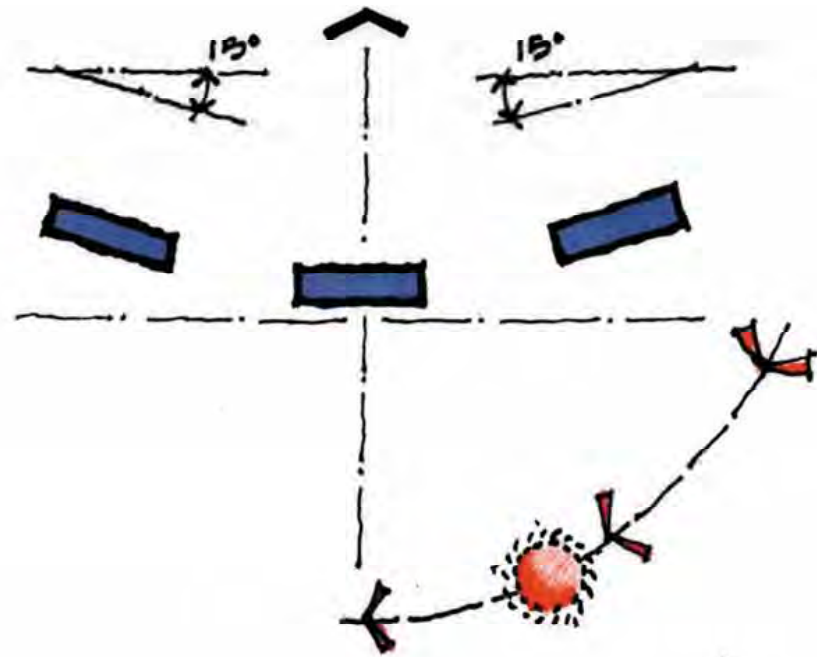

30% energy savings can be achieved if a house is orientated within 15° of south, providing its main living spaces are arranged to avail of the passive solar gains. Cork County Council's Energy Agency are able to provide free impartial advice on issues relating to energy efficiency when planning a site layout and designing a house. They can be contacted at:

Spa House
Mallow, Co Cork
tel: 022 43610
fax: 022 43678
e-mail: mallowre@indigo.ie

Eco-architecture and energy efficient design is a specialist skill. Refer to the Royal Institute of Architects of Ireland for practitioners in this field of design.

The sun's position changes throughout the seasons

Study your landholding carefully and select a site that gives you the best orientation to the sun, whilst also affording shelter from the weather, particularly prevailing winds. Choose a site where you can best achieve the 20 things identified on the previous pages. For example in the illustration above, choosing the site to the south of the road would enable a solid aspect (front of the house) to be presented to the road and a sunny, sheltered, private rear garden. Options for selecting the best site are examined overleaf.

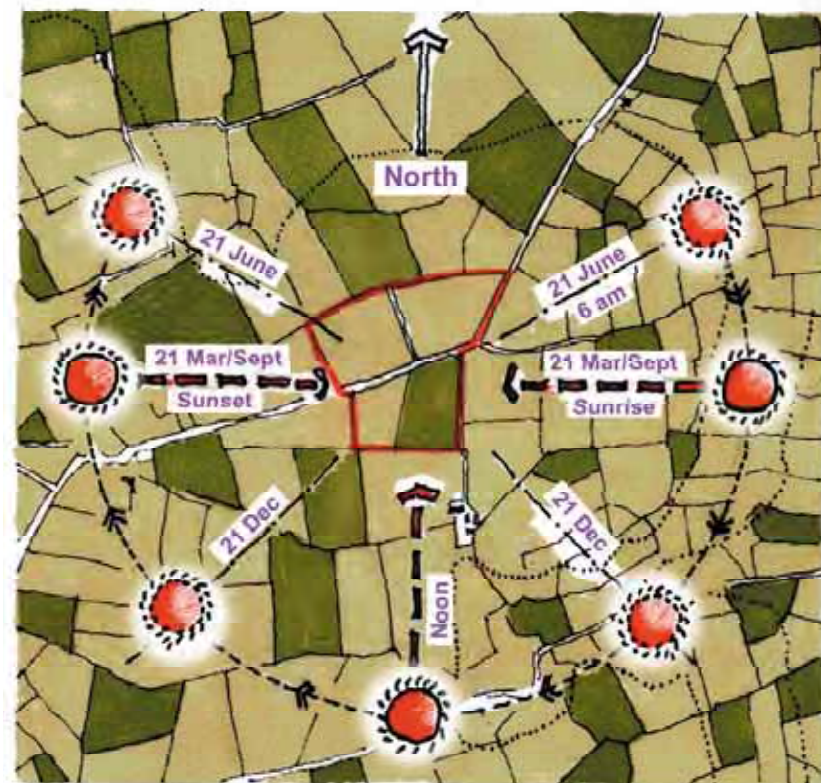

What is a Building Energy Rating?

As of January 2007 all new domestic dwellings require a BER cert and must comply with Part L of the building regulations. On January 1st 2009 the BER scheme was extended to existing properties. Under the legislation anyone offering a home for sale or rent is required to have a valid BER cert for the property. Buildings can also be rated before they are built and it is advised that a provisional BER is carried out on the proposed building prior to construction. In Ireland the scheme is operated by the Sustainable Energy Authority of Ireland (SEAI) www.seai.ie

search for the best site option

Some sites are easier to work with than others. In order to illustrate the implications of different site choices, the illustration opposite shows 8 potential sites located around a hill. A road winds around the hill with sites either above the road (on a higher slope) or below the road. The following pages outline the constraints and possibilities of each of the sites. All of the sites are laid out following common objectives to accommodate the “20 things” referred to earlier (see pages 30 & 31). Each site layout seeks to resolve privacy/screening conflicts: avoiding large glazed areas facing the road and discreetly locating car parking and utility areas. The layouts seek to break down the site, reducing extensive unnatural lawn areas, to develop more natural and rural-type gardens.

The following factors influence the siting of the house:

1. In every instance, the location of the septic tank/percolation area, determined by the fall across the site, dictates the position of the house;
2. Sites accessed on the outside of a bend, i.e. in this diagram below the road, will generally more easily meet the local authority entrance requirements noted later in this section. Sites on the inside of a bend, i.e. in this instance those sites depicted above the road, tend to have greater difficulty meeting entrance requirements;
3. The orientation, without exception, is dictated by low energy design objectives maximising on passive solar heating gains by orientating the house to the south, and sheltering from the prevailing southwesterly winds.
4. All the sites have at least 2 existing mature boundaries which are retained and utilised to minimise the visual impact of the new development.
5. Due to the terrain, some sites are naturally easier than others to site a house. In general, although not always, the sites above the road will be more prominent and therefore require more careful consideration with respect to house siting and screening. Privacy is affected by the orientation of the site. Sites B and E present the greatest difficulties as a south-facing house will be facing the road, therefore there will be conflicts in terms of privacy. Also sites with the southwest side facing the road will have evening patios facing the road (i.e. D and H).

The final site layout will depend on the existing site conditions as you find them. In the illustration opposite, sites A, C and F are the easiest to work with in terms of privacy, glazing, orientation and so forth.



Site Selection Guide: The constraints and possibilities of each of the sites below are set out in the following pages.

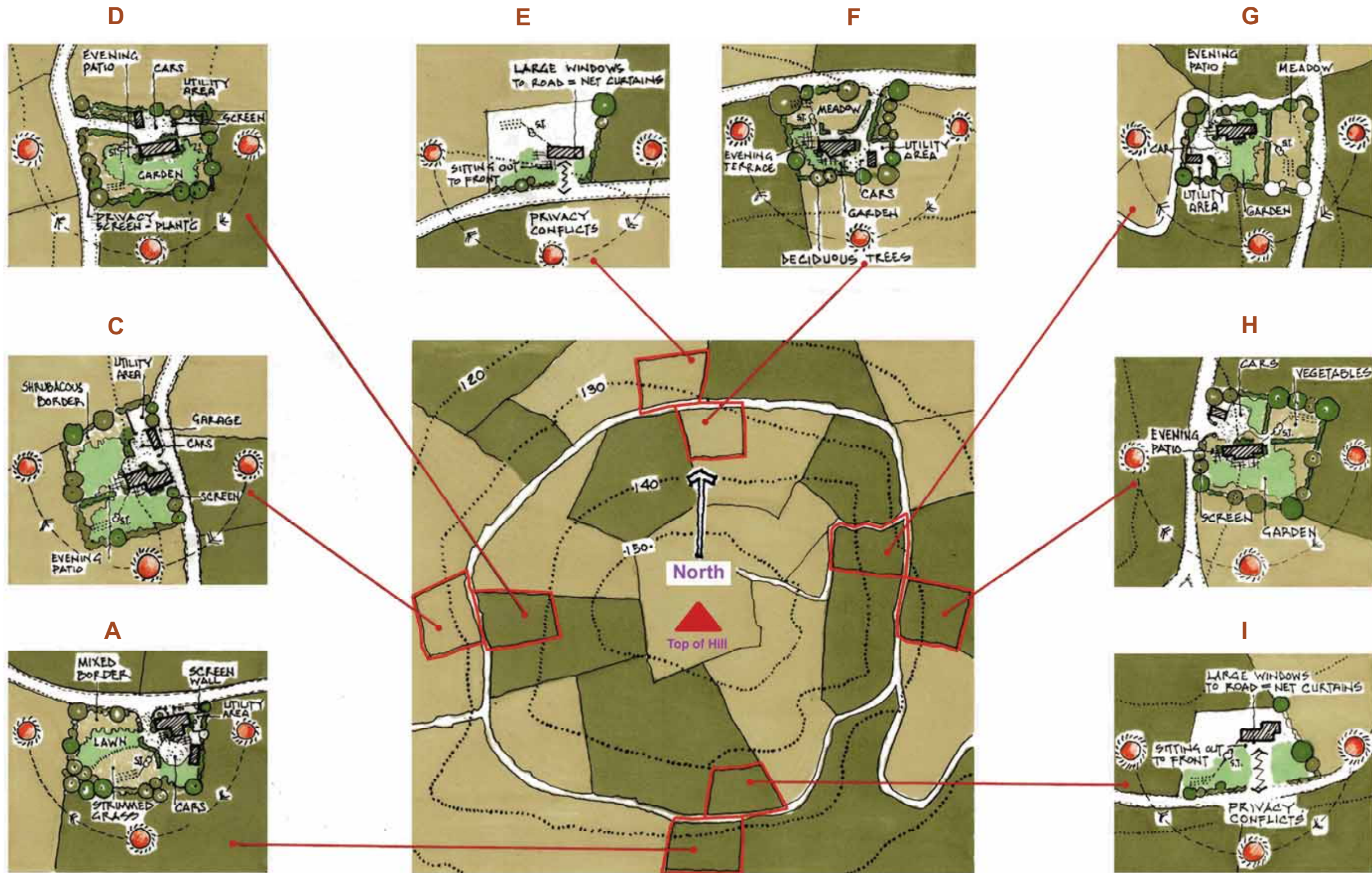

Eight sites surrounding a hill

Site Selection Guide: See pages 34 & 35 for an explanation of the context of these illustrations

A SOUTH FACING SLOPE – Site Below Road

- Fall across site enables septic tank to be located to the rear of the house, further away from the road
- House is set back from road with boundary treatment, which also effectively screens utility area from dwelling and road and enables maximum privacy in the layout and arrangement of the outdoor sitting area
- Garage is located to the rear of the dwelling and thus both the garage and car court are effectively screened from the road

Conclusion: Potentially a good site and attractive site layout.

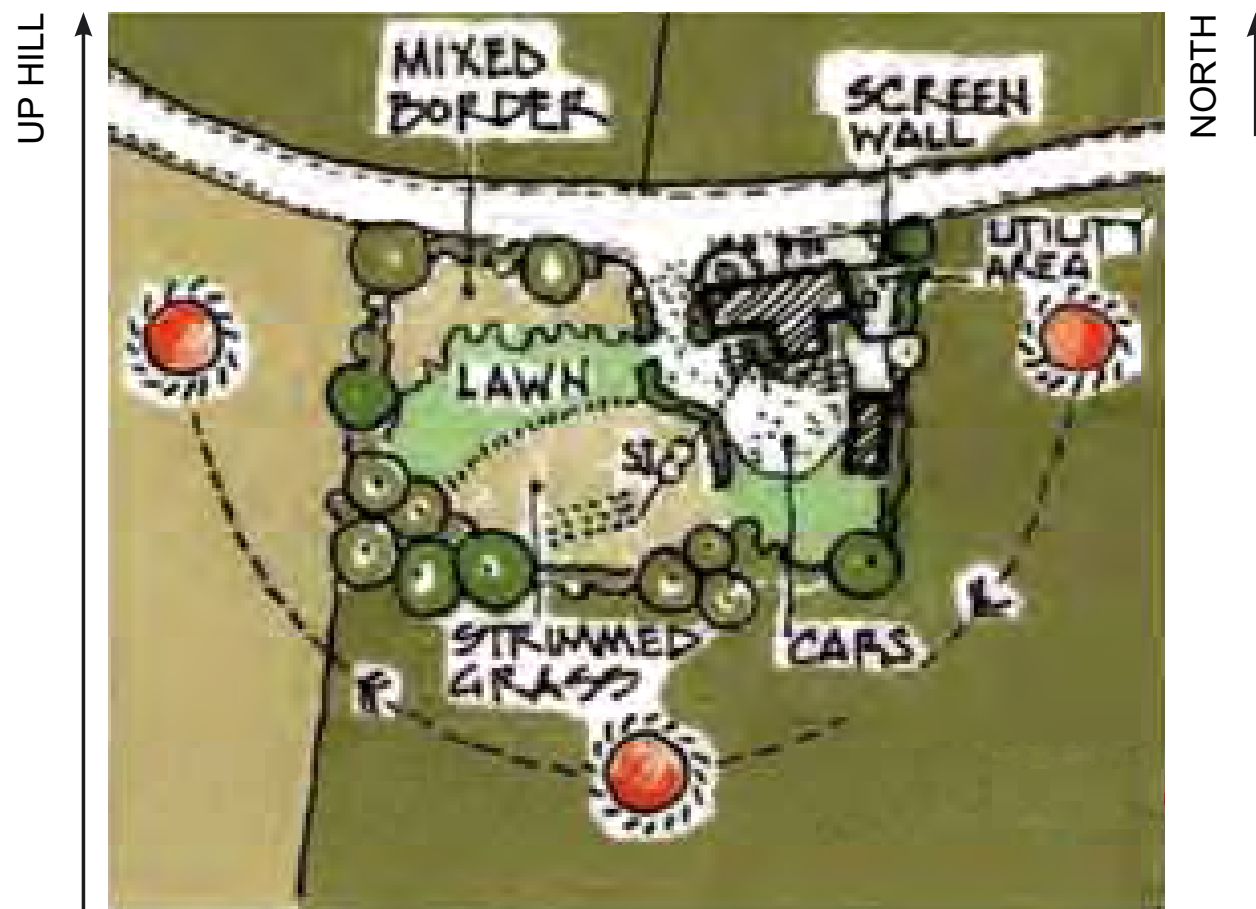

B SOUTH FACING SLOPE - Site Above Road

- Fall across site requires the septic tank and percolation area to be located to the front of the house, near the road
- To maximise sun and daylight the house needs its largest windows to the roadside, and the location of the outdoor sitting area to the front of the dwelling nearer the road, both of which conflict with privacy

Conclusion: Although this site is south-facing, it is not such a good site as large windows with net curtains will be necessary on elevation facing road to maximise daylight yet facilitate privacy.

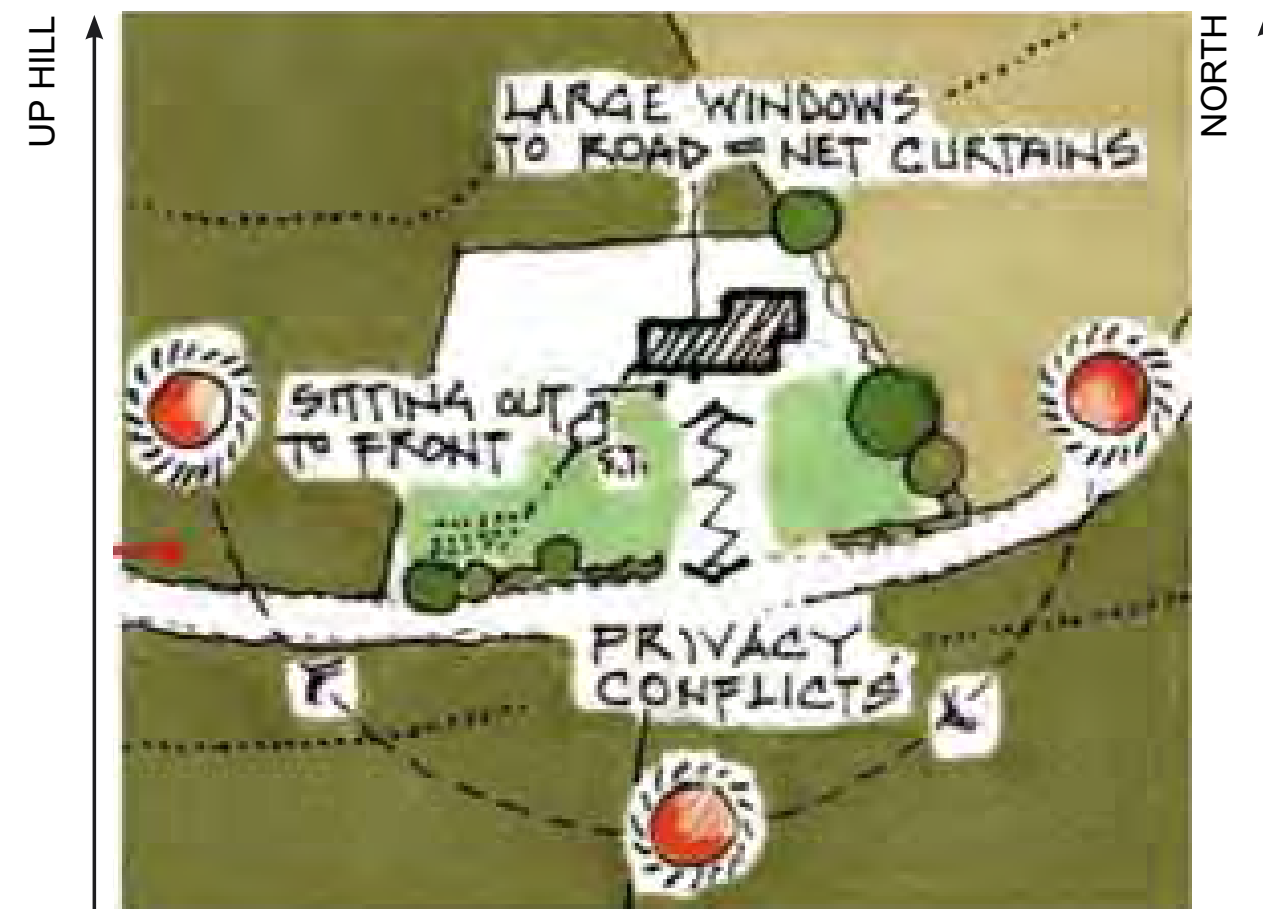

Site Selection Guide: See pages 34 & 35 for an explanation of the context of these illustrations

C WEST FACING SLOPE – Site Below Road

- Fall across site places septic tank and percolation areas at lower area, furthest away from road while house and garage are positioned in traditional Cork relationship with road – i.e. gable on and lengthways respectively at road edge
- Existing boundaries used in part to screen off utility area
- Garage location screens car court from road
- Layout of house and site affords maximum privacy to evening sitting out area

Conclusion: potentially a good site and attractive site layout.

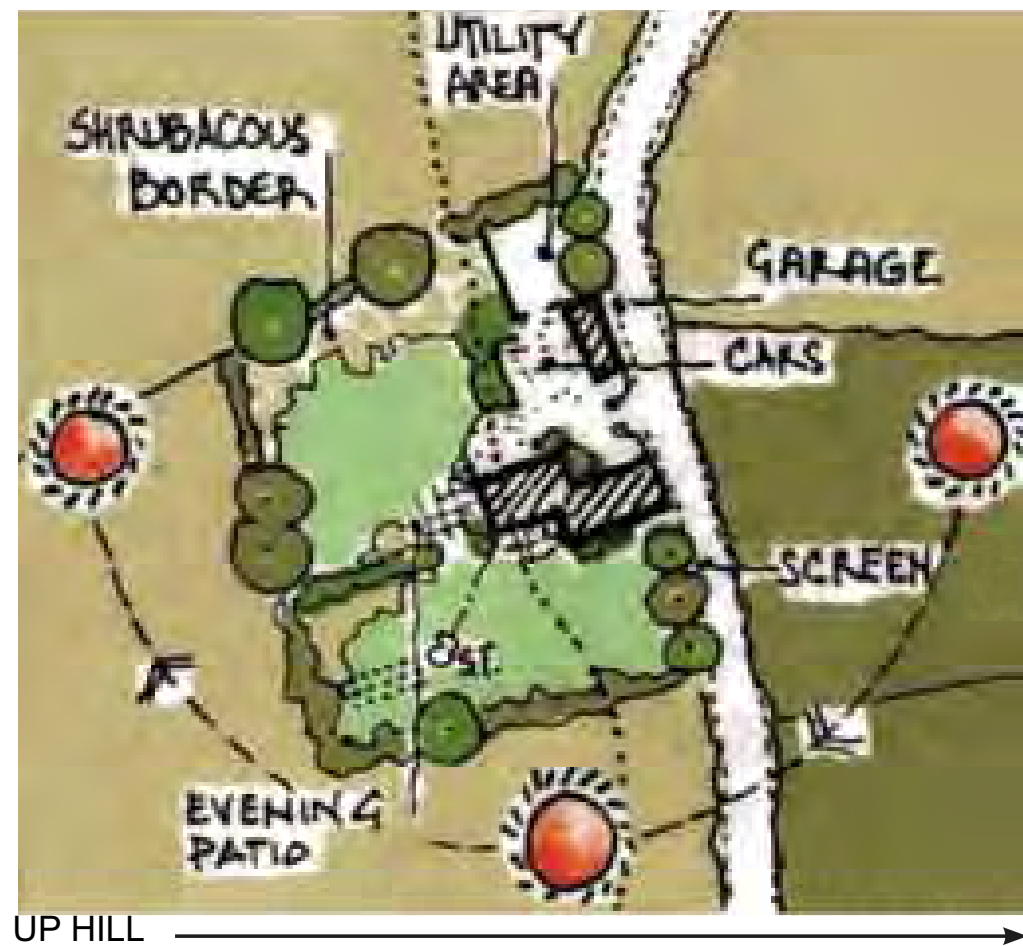

D WEST FACING SLOPE – Site Above Road

- Fall across site pushes house back up hillside with septic tank and percolation area on lower area near road
- House located towards existing northern boundary for shelter – boundary will form backdrop to house for most part when viewed from road
- Proposed garage location creates screened off car court
- New landscaping to 2 new boundaries to form native hedgerow

Conclusion: A potentially good site, but effective short-term leading to longterm privacy screening of South and West areas of house will need careful handling.

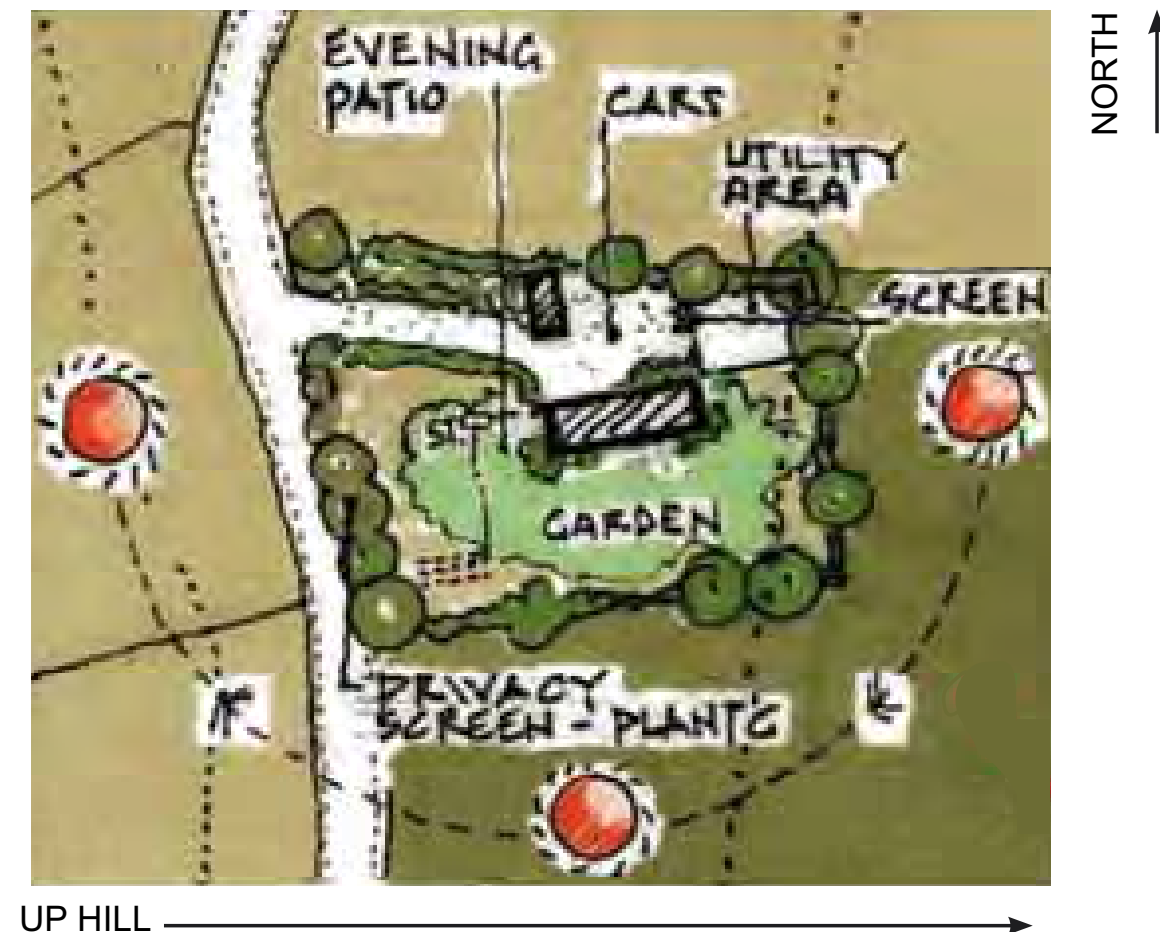

Site Selection Guide: See pages 34 & 35 for an explanation of the context of these illustrations

E NORTH FACING SLOPE – Site Below Road

- Fall across site places septic tank and percolation areas at lower end furthest from road
- To maximise sun and daylight the house is set back from road with its largest windows to the roadside, and the location of the outdoor sitting area to the front of the dwelling nearer the road, both of which conflict with privacy

Conclusion: This is the least favourable site as the site is north-facing and requires large windows with net curtains on elevation facing road to maximise daylight yet facilitate privacy

F NORTH FACING SLOPE – Site Above Road

- As with other sites above the road, the fall across the site requires that the house be located up hillside with the septic tank and percolation area on the lower meadow
- House located to southern edge of site because of contours
- Car court screened from road by house, garage and landscaping
- Utility area screened from house
- Southern boundary of deciduous trees to enable maximum light to dwelling in winter and summer shelter, provides backdrop to house in summer

Conclusion: Although not a great site, interesting layout enables best use of north facing aspect.

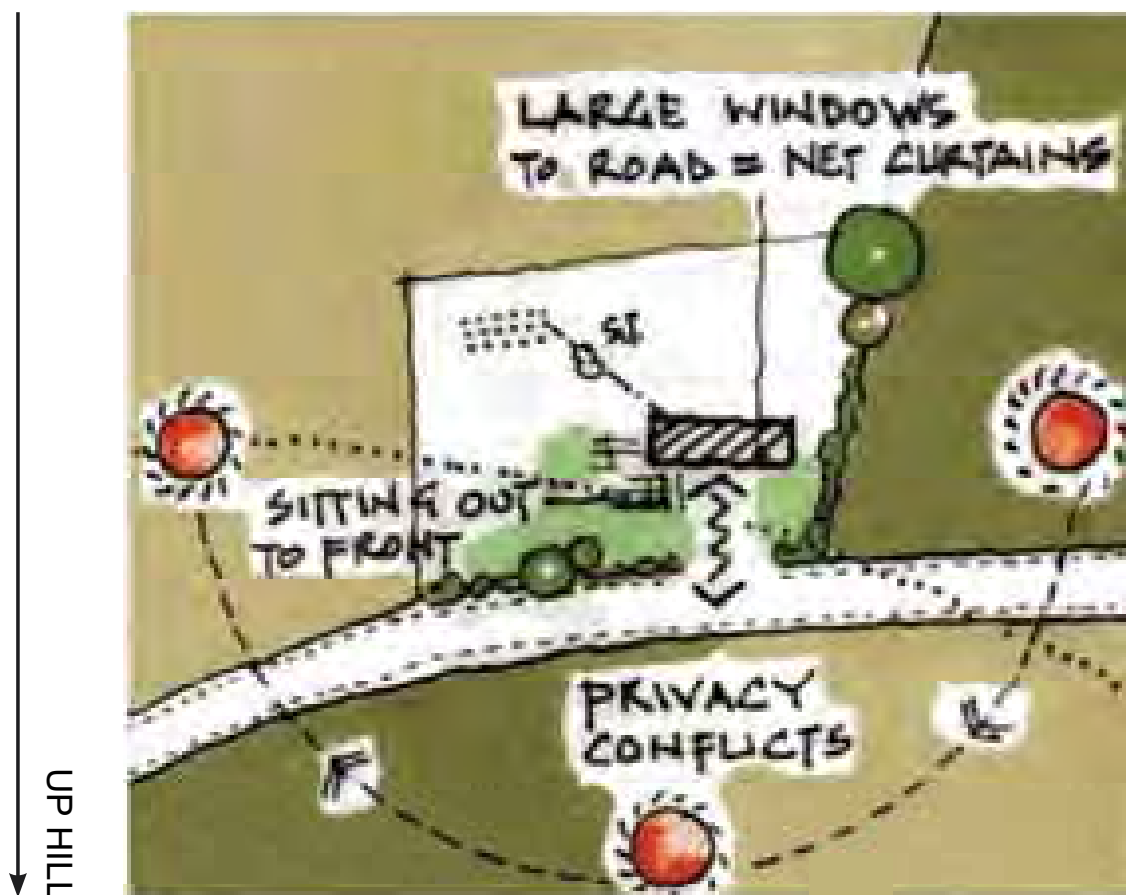

Site Selection Guide: See pages 34 & 35 for an explanation of the context of these illustrations

G EAST FACING SLOPE – Site Above Road

- Fall across site pushes house up hillside with septic tank and percolation area on lower meadow closer to road
- House located to northern boundary of site, off hillside access road
- Both garage and utility area located to rear of house and screened from road by garden and landscaping
- Site layout maximises privacy to evening sitting out area, however location of vehicle entrance and garage reduces size of evening patio

Conclusion: A potentially good site with safe access off a side route.

H EAST FACING SLOPE – Site Below Road

- Fall across site places septic tank and percolation area at lower area to the rear of house and away from road
- Garage location coupled with new planting screens off car court from road
- As with West Facing Site above road, boundary will form backdrop to house when viewed from road

Conclusion: Potentially a good site but effective short-term leading to longterm privacy screening of South and West areas of house will need careful handling.

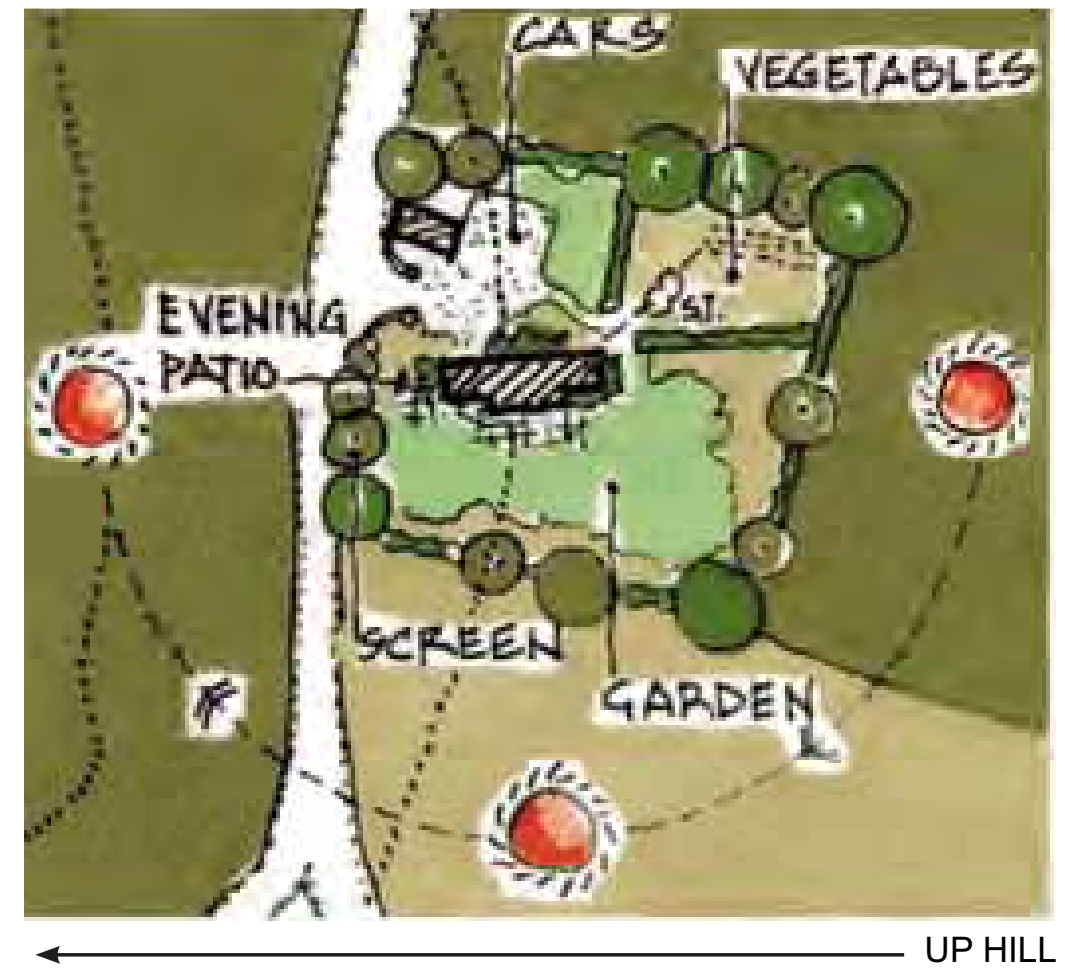
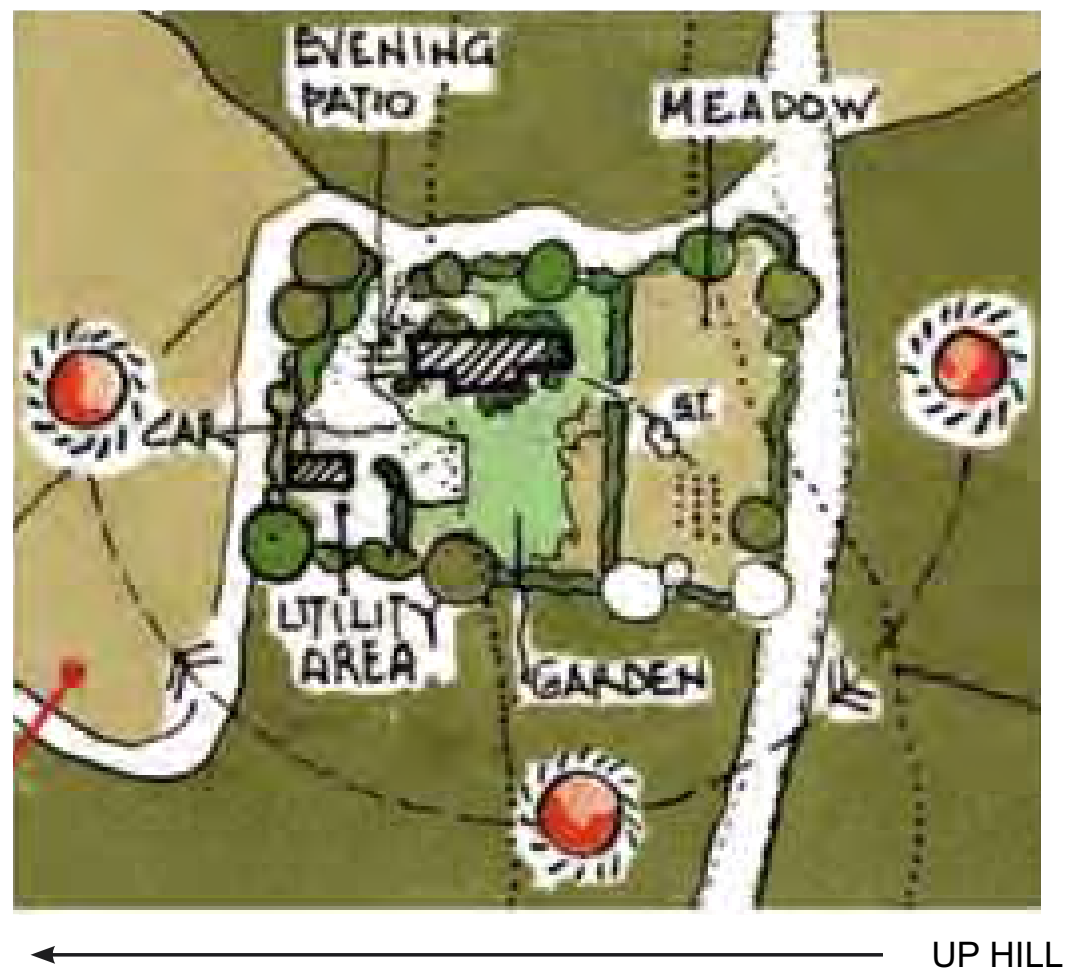

dealing with contours

It is important to pay particular attention to the sloping contours of the site to determine if a specifically designed dwelling could be accommodated on the site; making use of, and working with, the sloping site levels. Digging out a site, or creating an artificial platform, is expensive and can make the house unduly prominent.

In some less sensitive landscapes it may be possible, and indeed appropriate, to modify the site by excavation in order to reduce the visual impact of the development. In certain circumstances, excavation or under-building may also be used to reduce the exposure of the dwelling(s) to the prevailing winds by directing wind around or over structures while enabling a more pleasant visual integration into the surrounding landscape. However, caution should be exercised as excessive excavation can lead to permanent scarring of the landscape, in the form of a conspicuous building platform which may not be concealed by the dwelling (as per the illustration below left). Similarly excessive under-building will appear as an unnatural platform unrelated to the surrounding landscape (below right).

Where excavation techniques are adopted, the excavated material should be graded over the remainder of the site or recycled to create a landscaped garden.

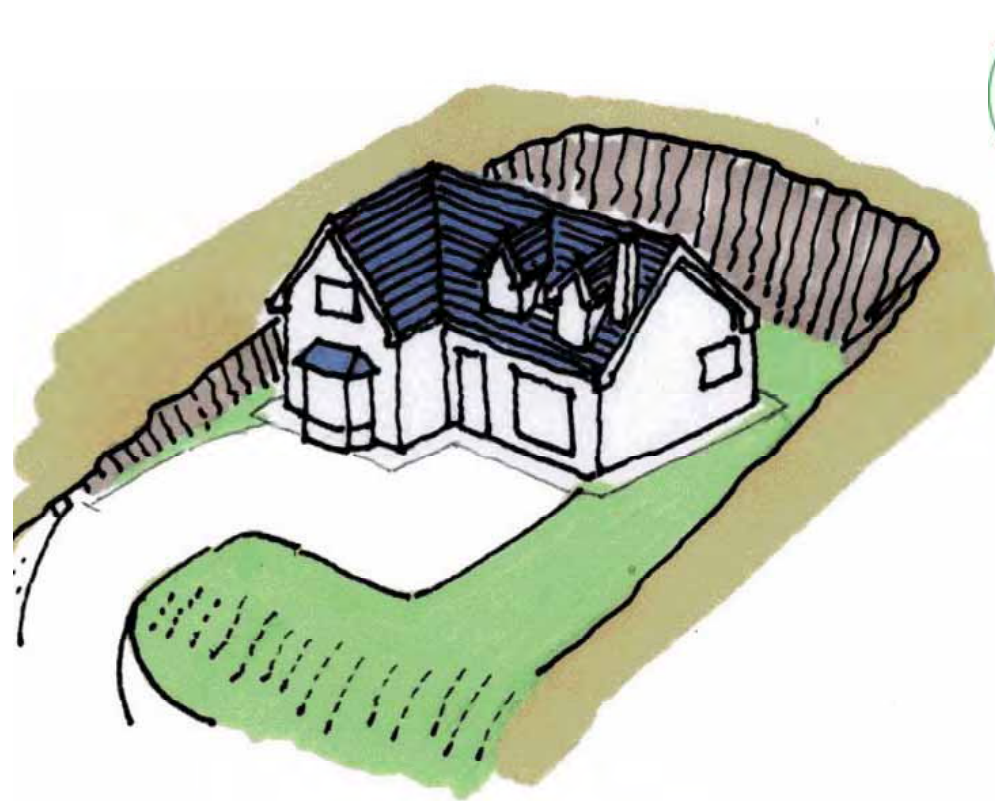

Avoid over excavation. A deep gouge from the hillside creates long term land slippage problems and a poor environment for the householders



Avoid mounding up to form a flat site. This makes the house more conspicuous in the landscape, reduces its ability to retain heat/energy and exposes the exterior to the worst effects of weathering

run with the slope

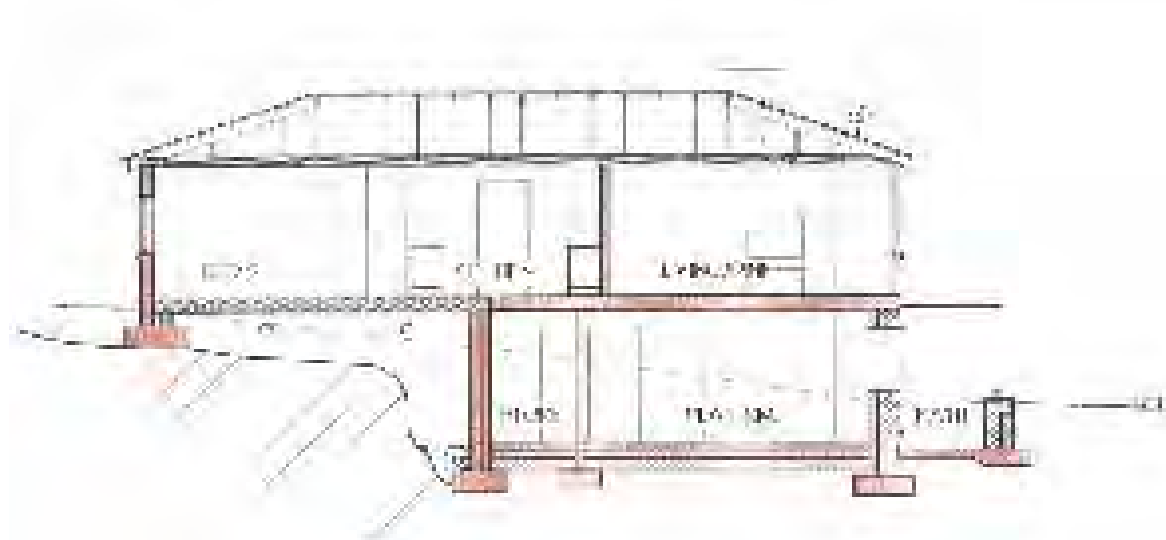

A slope can be accommodated without altering the ground, simply by changing the internal floor levels to suit. Seek a naturally flat site or cut into the hillside. Try to orientate the building with the contours to give an integrated appearance with the land, provide shelter and warmth, and reduce energy loss due to exposure.



1½ & 2 Storey Split

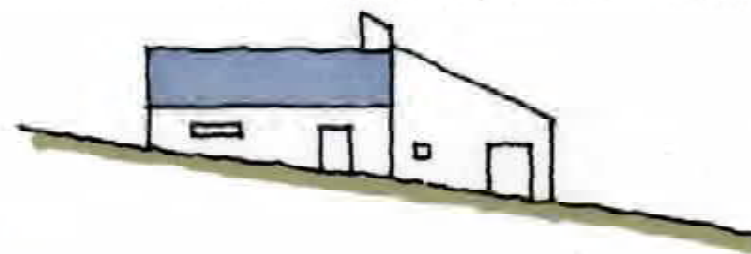

Contemporary Monopitch Split

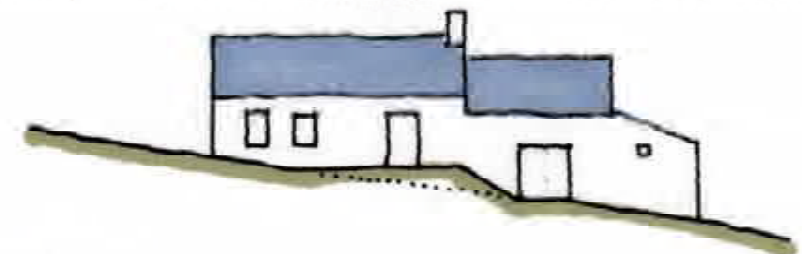

Traditional Stepped Levels



rural gardens for rural houses

In part one of the guide, the importance of 'linking with the land' when choosing where to build was emphasised. The essence of this link is of course the garden and garden design which will determine how well this link is achieved. Irish country gardens stand out from their suburban counterparts by the way they embrace the house and appear to seamlessly connect to the natural landscape from which they arise. Enclosure, privacy, semi-wild habitat, the absence of expansive lawns and the appropriate rural boundary treatment are hallmarks of a more naturalistic approach.

Principles for 'natural' Gardens

- Plant in tune with the landscape character of the site location;
- Avoid suburban type garden layouts and plant species - e.g. Leylandii and Griselinia hedges, shaped dwarf Conifers, Phormiums and Pampas Grass;
- To achieve informal, relaxed garden layouts use gentle lines, curves, asymmetry etc. which appears appropriate in rural vernacular settings. Formal, symmetrical layouts with long straight lines are seldom appropriate;
- Avoid/reduce large areas of mown lawn - they are high maintenance, look 'artificial' in many rural locations and require regular application of weedkillers, which harm wildlife. Wild meadows or strimmed grass areas are lower maintenance and are frequently more appropriate;
- Create new mixed hedgerows of native/local species to maintain biodiversity and ecological regional diversity. Minimise on large single species hedges;
- Devise garden layout and select plant varieties which will attract and support wildlife;
- Select plants, or plant varieties, which are resistant to disease and 'pests' - to reduce reliance on harmful chemicals, insecticides, slug pellets, etc.;
- Limit the use of suburban 'ornamental' exotic specimen trees near roads in the countryside.



● a planting zone between path and house softens its appearance



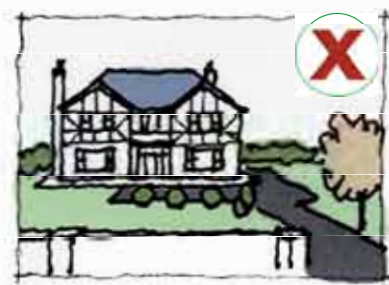

Avoid suburban layouts + garden treatment

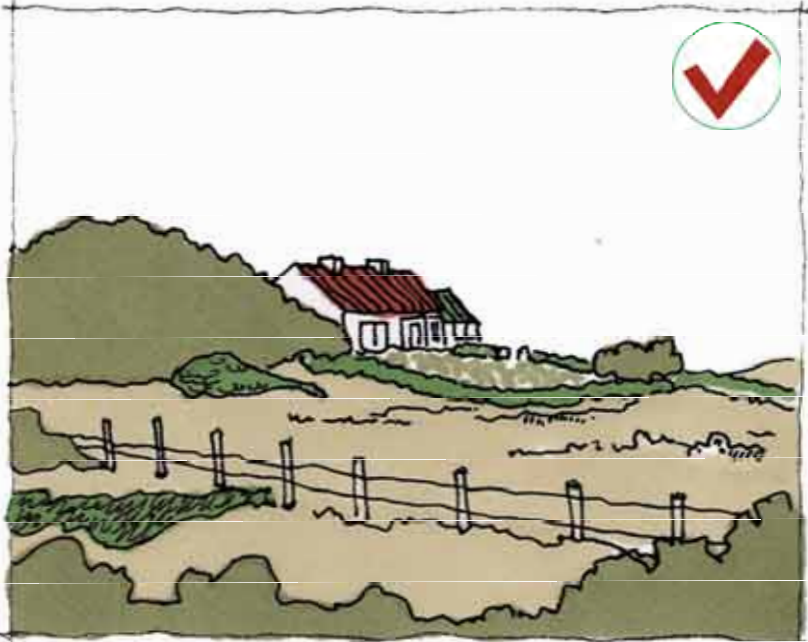

Naturalistic planting links house to location, no visible lawn



Garden treatment without lawn between house & road

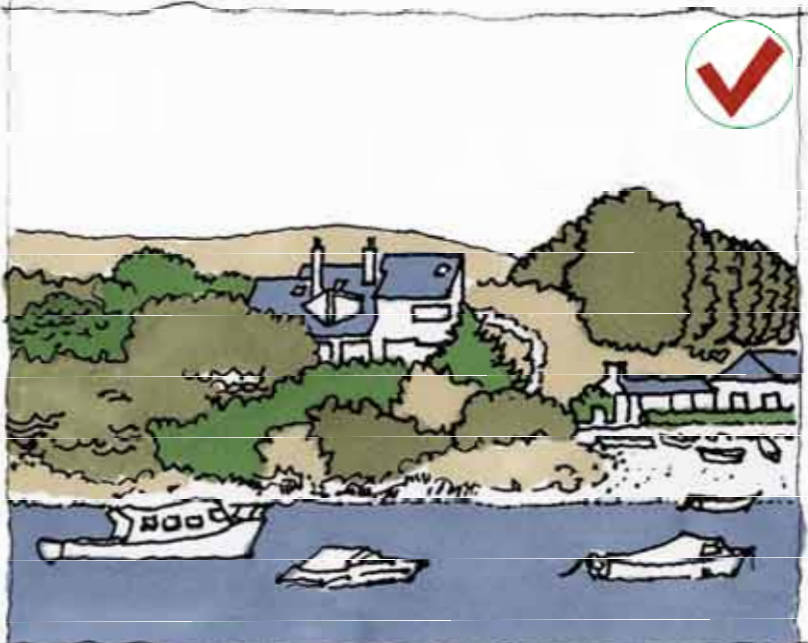

Existing & new trees settle contemporary house on site



Absence of lawn + use of backdrop anchors the house to the landscape



The rural garden - a haven for wildlife

creating new boundaries

Part one of the guide has indicated that sites with at least two, or preferably three, boundaries already in place, in the form of existing hedgerows or walls, should be selected when choosing a new site in the countryside. This makes completing the remaining boundaries much easier in terms of linking the house to the landscape. This can become a very difficult task if all, or a substantial amount of, the boundaries are new and are required to be put in place to give the property shelter, enclosure and privacy. Landscaping the boundaries of the house provides two useful functions: firstly, it provides shelter from the prevailing winds and secondly it can soften the visual impact of the development allowing greater integration with the surrounding countryside.

However, such is the variation of landscape character across Cork that care is needed when deciding what form new boundaries should take. In rocky uplands or coastal areas, for example, additional landscaping may not be possible or indeed desirable at all. Take your lead from the landscape character assessments in the County Development Plan and if necessary take advice from your local planning office. Otherwise take a look around and see what techniques other properties in the area have used to make appropriate boundaries and create shelter.

- Devise and develop an appropriate landscaping layout in parallel with good site layout principles - house entrance location, car area, privacy screening, creating shelter and backdrop are all integral to successful rural house design
- Commence a boundary planting programme before or simultaneously with building works
- Buffer the house as viewed from the road
- Avoid 'full frontal' - open to road site layouts

Stone walls, or stone and sod walls, as much as hedgerows, are a distinctive feature of parts of the countryside. The conservation of existing stone walls will help to root new buildings more naturally in the landscape. Traditionally Cork rural walls had a substance. All too often these are being replaced by narrow walls with busy detailing. Stone walls, or stone and sod walls, particularly in areas where they are prevalent, are preferred over plaster block work, although in some circumstances harled block work may be suitable. In general decorative brickwork or ranch style timber fencing detracts from the rural landscape and should be avoided.



Rural Roadside Boundaries and Presentation



Hedgerow removed - house & site given suburban treatment



Hedgerow removed - unattractive stone wall, suburban garden gives full impact of large house

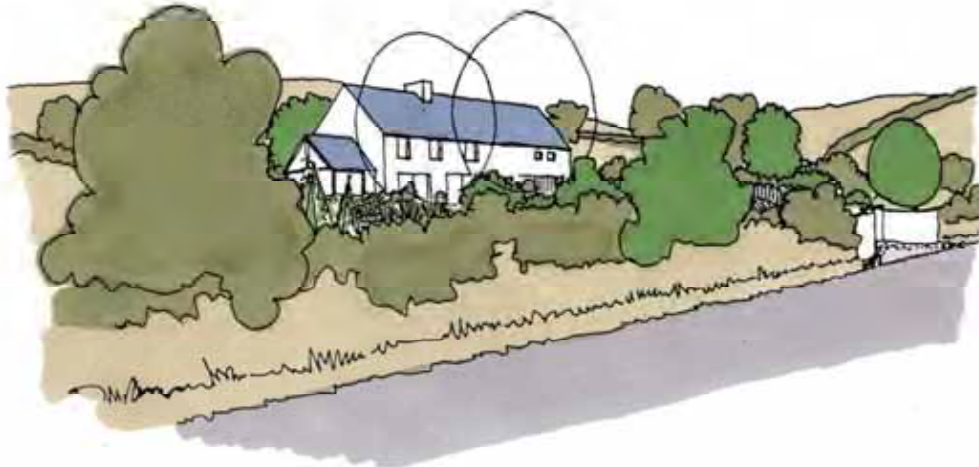

Hedgerow maintained with added planting - house buffered from road

Wall Construction Details

Simple capping Tight recessed mortar joints Main axis of stones held horizontally

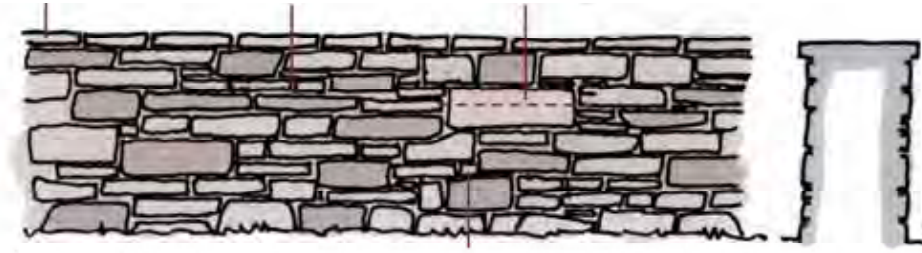

'Pinnings' used for support / fill gaps

Attractive stone wall

Main axis of stones not horizontal

'Shiners' large stone placed upright

Ugly 'bitty' spiked capping with cement fill



Large wide mortar joints flush with surface

Ugly stone wall



Traditional attractive wall cappings



Narrow wall with mean cappings and ramped lifts

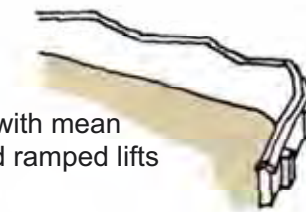

Mean, narrow wall, mean cappings with steps



Narrow wall with many piers

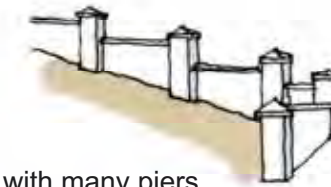

Thick wall follows line of ground



Boundary walls and slopes

trees & shrubs found in cork some examples.....



● *mixed hedgerow - native & introduced species*



● *hawthorn*



● *bramble*



● *beech (winter)*



● *fuchsia*



● *blackthorn*



● *privet (variegated)*



● *gorse*



● *guelder rose*

new planting

Hedgerows and shelter belts are the backbone of wildlife habitat and also help support deciduous saplings. Hedgerows are either man made or natural. Manmade hedgerows are usually at the edge of fields that have been cleared for agricultural use or have been intentionally planted for wildlife or aesthetic value.

Hedgerows provide food and shelter for a variety of birds, mammals, butterflies and other insects. When planting new boundaries (hedgerows or shelter belts) in rural areas it is a good idea to plant a variety of trees and shrubs. Planting rows of bushes or bushes mixed with a few trees is a common way to start a hedgerow. Try to choose trees and shrubs that blend with the local landscape. This is particularly important with flowering species. A selection of indigenous and naturalised hedging plants should be used. Most of these are inexpensive and easily obtainable through local garden centres. The illustrations in this section, and the annotated schedule of plant species in the Appendix, may help you with your choice.

The main factors to consider when establishing a new boundary, in order to achieve maximum benefit from the trees in terms of shelter and energy savings are:

Siting: Shelter planting should cut across the path of the wind and should be sited to make use of and improve natural shelter features, such as ridges and rocky outcrops. Planting on ridge tops is not recommended due to high levels of exposure.

Height and Length: As a rule the sheltered zone will extend for a distance of 20 times the height of the trees (e.g. if the height of the trees is 1.5m, then the area sheltered will extend for 30m) and will become effective when the length exceeds 12 times the height (e.g. if the height of the trees is 1.5 m, then shelter planting will need to cover a length of 18m to be effective).

Profile: A shelter belt should have a hedge or wind tolerant shrubs on the windward side and taller trees in the centre.

Permeability: A good shelterbelt or hedge filters the force of the wind without causing damaging turbulence.

(adapted from Building Sensitively in Ireland's Landscape)

Trees should be planted from the beginning of November until the end of March when the tree is dormant. Remember that as trees mature they require more space so should be planted, on average, at 60cm intervals. To help establish trees, choose healthy specimens under 1.5m tall.



● Elm

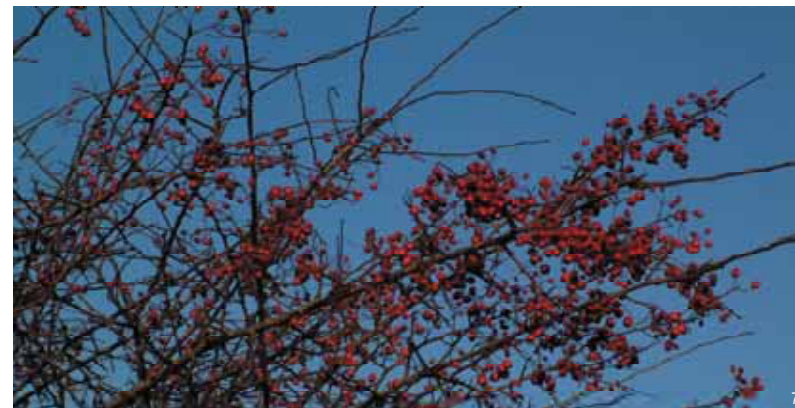

● Hawthorn (in December)



● Holly and Blackthorn in flower

making an entrance

It is a common requirement of the County Council that the vehicular entrance to new developments provides clear forward visibility. The entrance must usually be recessed 4.5m from the edge of the road and have a minimum width of 3m at the inside piers, increasing to 12 m at the road edge, a minimum setback of 2.4m from the road over 50m is also usually required for visibility. Whilst this can be achieved in a variety of ways, all too often it leads to the loss of stone walls or established hedgerows located along the roadside boundary. Too often they are replaced by unsympathetic fencing, pre-cast decorative concrete blocks or crude, artificial looking stone walls.

It is the entrance gateway that presents the house to the street or road and therefore it is an important element in the overall design and layout of the dwelling and its site. Where an existing boundary feature must be removed, it can easily be replaced with an earth or sod and stone boundary, or planting of a new semi-mature hedgerow of indigenous species. Existing stone walls should be relocated behind the line of vision along the site entrance as specified by the County Council. The layout of internal access roads from the public road to the dwelling should be carefully thought out so they can follow the contours of the site, crossing them gently in order to avoid highly visible and unnatural looking straight access roads that may be visible from long distances within the landscape. For surfacing, local gravel and tar are more natural looking and appropriate to a rural setting than tarmacadam.



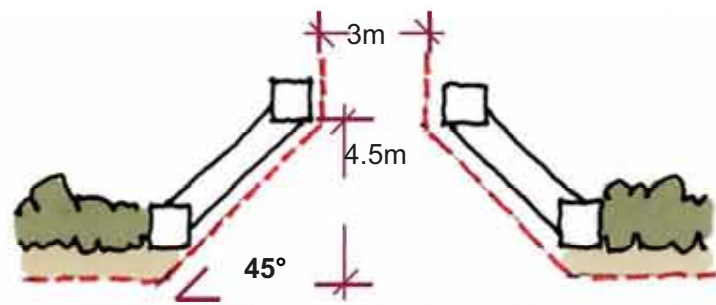

Basic Layout Requirements

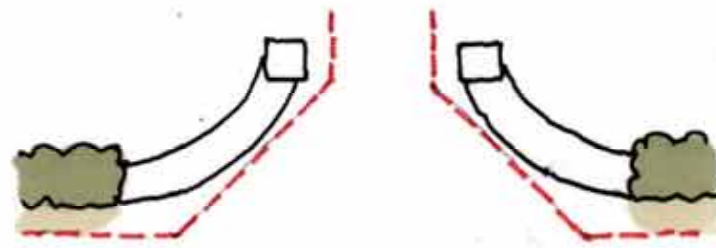

Outer Pillars not always required

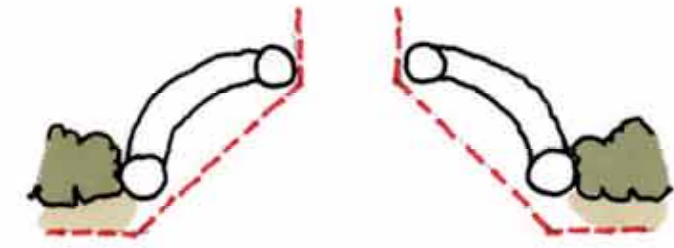

Wider entrance sometimes required

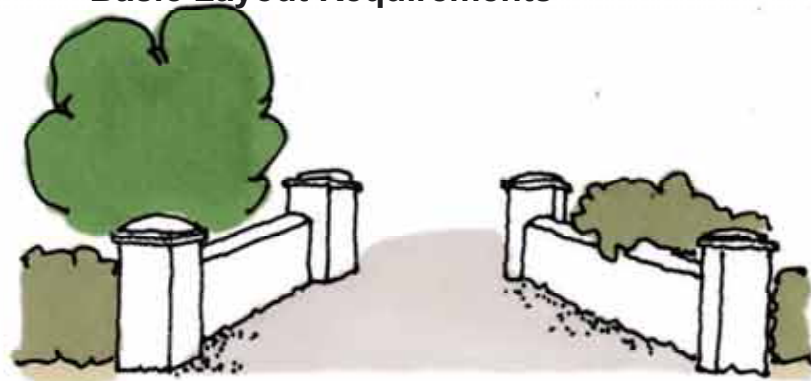

45° Splayed

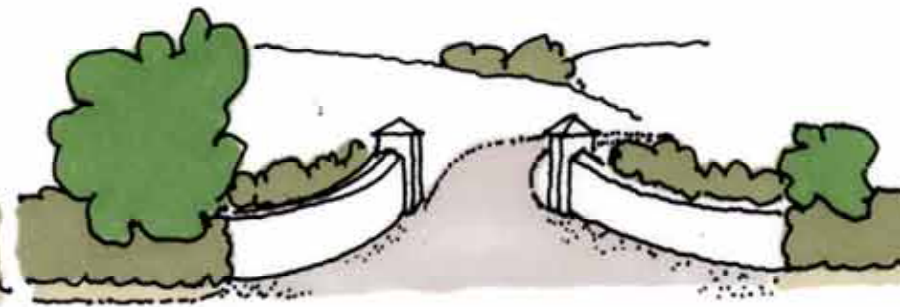

Convex

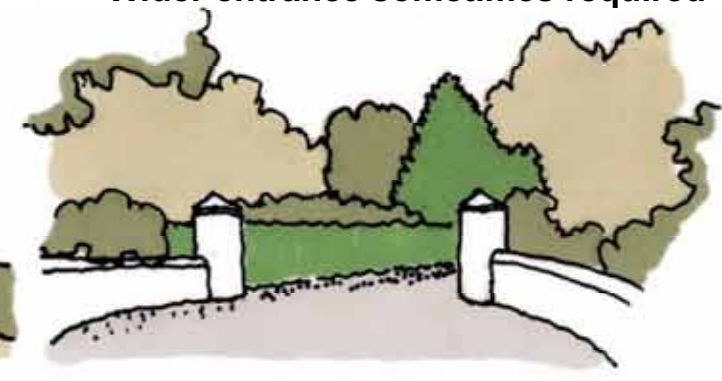

Concave

Entrance Types

Gentle lines look natural - with simple stout pillars

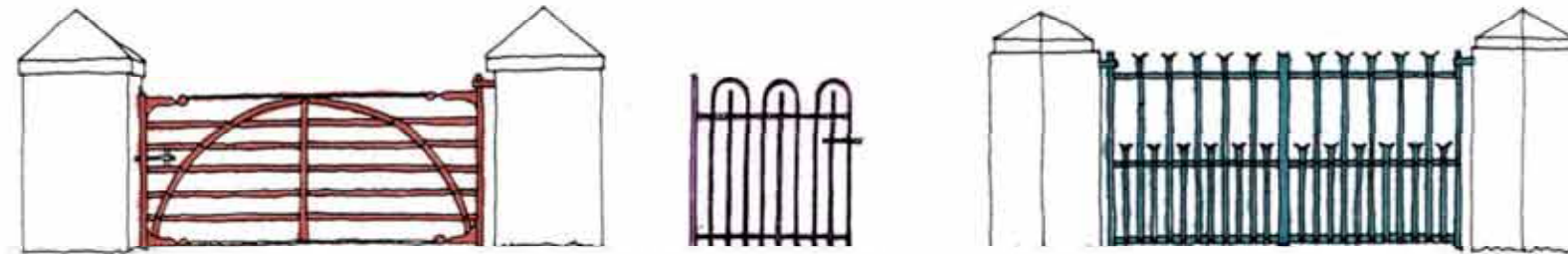

Cork countryside gates

Simple, no-nonsense, well crafted wrought iron - decent simple pillars

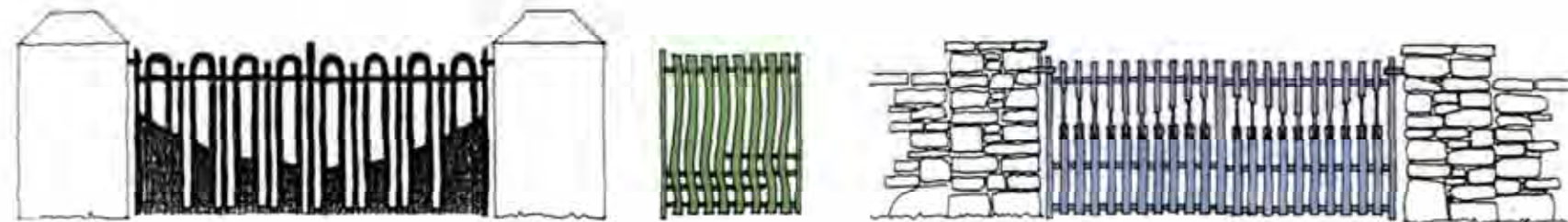

Possible contemporary metal rural gates

Informed by tradition and encourages local craftsmanship



Avoid fussy & over-elaborate entrance gates & lights as well as spikey 'frills' & 'bits' on the stonework



summary and checklist site layout

have you?

Fully considered the 20 items in your site selection and site layout?

Achieved an orientation within 15° of south with main living spaces facing south? - i.e. have you achieved optimum aspect?

Studied the options for site arrangement and addressed issues such as

prominence? - devised a house and site layout to minimise visual impact

shelter?

privacy and screening?

presentation to the road? - attractive frontage, sufficiently buffered from the road

Managed the contours of the site? - ensuring the house sits comfortably into the site

Designed the landscaping and garden to link with the natural features surrounding the site? - are the new plants indigenous/native?

Maintained existing roadside boundaries and supplemented with new boundary treatments appropriate to the landscape setting?

Designed a discreet and safe access to the property?



part three

appropriate house design

- Signature characteristics of a Cork rural house
- “Proportion, proportion, proportion”
- Scale
- Form
- The problem: bigger, higher, wider
- Advantages of the narrow plan form
- The deep plan form
- Summary & Checklist

* This guide does not address **building regulation** matters. Designers should satisfy themselves that fire safety and building regulations requirements are met. This may require specialist expertise in some cases.



design

As we enter this new millennium we must consider building homes which more confidently reflect our advanced technology and modern lifestyles. At the same time we have a duty to demonstrate an environmental and cultural awareness of the countryside and our built heritage. The success of truly modern rural housing in Cork will be judged on how well these two objectives are met. The aim of this guide is to promote design innovation and flair that is contemporary and firmly of its time. It is also the intention of this guide to ensure that new development acknowledges, respects and reflects the design features and characteristics that contribute to the rural character of the County.

This section of the guide has to deal with fairly complex subjects such as proportion, form, scale and massing. These subjects rarely get the attention they deserve when new houses are being planned, yet they explain why many of the pattern book houses that are built today look at odds with our design tradition in Cork and sit so uncomfortably in our landscape. The following pages are aimed at those who draw houses and submit planning applications, with the intention of reasserting some simple first principles with a view to developing more appropriate and well-mannered rural buildings. Getting issues such as proportion, scale, form and massing right and the detail can more easily fall into place. Get them wrong and no amount of frills will compensate for a potentially clumsy, awkward and unattractive structure.

It is strongly recommended by Cork County Council that, wherever possible, the services of a skilled design architect are sought to deal with these issues, particularly on sensitive or difficult sites.



Picture on opposite page - Interpretation of the simple form of the Irish cottage into a contemporary context. Incorporation of three gables produces elegant and spacious internal spaces.

contemporary rural design

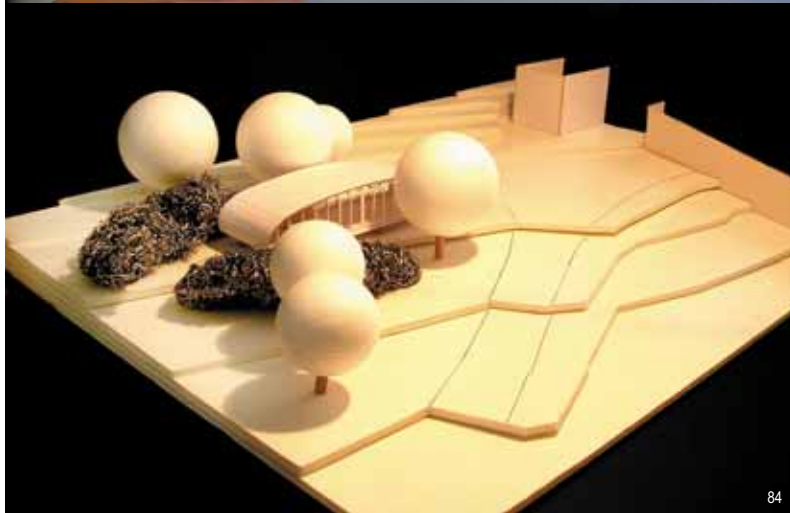





88



89



90



91



92



93



94



95



96

a cork rural house ... signature characteristics

It is hoped that, by understanding the signature characteristics of our rural buildings, new rural houses will be designed that are more in harmony with our built heritage and countryside.

Signature characteristics to develop

- Simplicity of form
- Little or no modelling of front plane of building
- Well proportioned
- Balanced
- Quality in materials
- Solid, simple construction
- Absence of frills

Alien characteristics to avoid

- Complexity of shape
- Busy
- Poorly proportioned
- Large boxy looking
- Slap on `bits' and `frills'
- Proliferation of white plastic
- Suburban site treatment

Traditional buildings in Cork demonstrated basic functional scale and simple proportions and little or no decorative detailing. Simple vernacular rural dwellings were generally single storey structures, with a rectilinear plan, usually no more than one room deep, with gable end or hipped roof details. From the second half of the 19th century corrugated iron and slate replaced thatch as the dominant roofing material.

Ancillary buildings, byres and extensions were frequently added in an incremental fashion onto the gables of dwellings with lean-to roofs or split level roofs. These provided a visual break to the linear nature of the dwelling and contributed to the evolving vernacular form. Two storey dwellings were traditionally of simple classical proportions, generally retained the one room depth and had a symmetrical façade.

In summary, Irish vernacular architecture is simple, honest and has inadvertently almost effortlessly integrated into the landscape; an unconscious technique that should be mastered in contemporary rural design practice.



proportion, proportion, proportion

Architect Robert Lorimer (a much regarded designer of Scottish houses) is quoted as saying that when it came to architecture there were only three things which were important: - Proportion, Proportion and Proportion.

Certainly, proportion is fundamental to and a very significant part of successful design. It is something that affects every aspect of a house because each and every element is relative to the whole and that in turn is relative to where it is and what surrounds it.

To define or explain it is difficult. Simply put, many would say that proportion is to building what harmony is to music. To ignore or dismiss it as a design nicety is a mistake.

Traditional rural homes maintained a balance of proportions between the walls and openings (windows and doors) by demonstrating three key factors:

- height of the building relative to its openings, with openings exhibiting a vertical emphasis;
- a high solid-to-void relationship (i.e. greater wall surface area than windows and doors);
- a simple, symmetrical arrangement of features (composition);

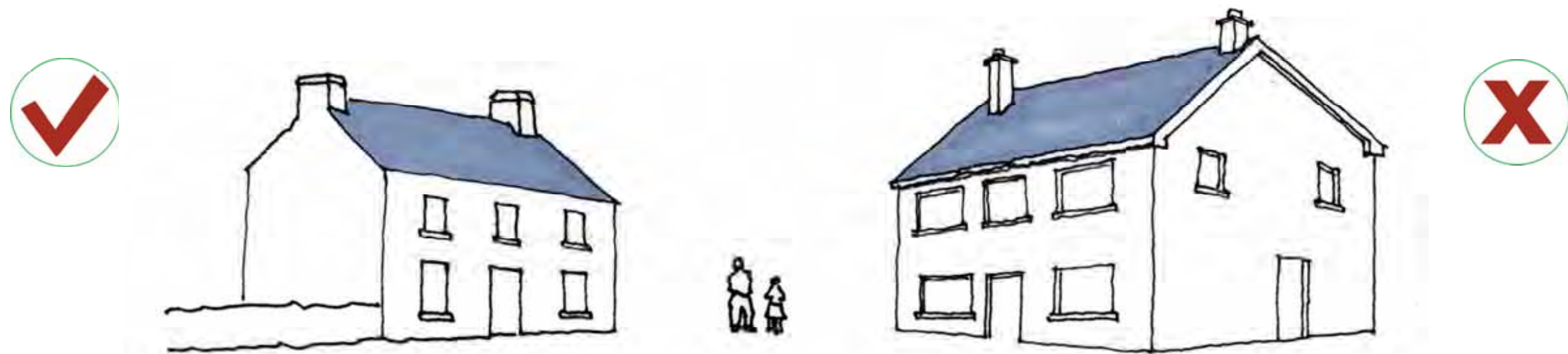

Irish rural houses are generally characterised as being simple buildings, with horizontally proportioned roofs sitting on horizontally proportioned walls that are counterbalanced by elements with a strong vertical emphasis such as gables, chimneys and windows. This balance is destroyed all too frequently in current buildings by using much larger horizontal emphasis windows which reverse the solid-to-void relationship (i.e. the windows dominate) producing a structure that looks weak and unbalanced; lacking the simplicity and strength of traditional buildings as in the sketch above. The following pages seek to redress this imbalance and suggest ways in which a higher percentage of new houses, with all modern comforts, can still connect with and develop from what has gone before.

height

Current Irish building regulations advice makes it impossible to replicate the proportions of vernacular houses. Even where the openings display a vertical emphasis, the solid-to-void relationship is ruined by the larger gap between the ground and first floor windows creating a larger surface area of wall.

Building regulations and other factors have contributed to making our buildings higher, which, if insensitively handled, can overwhelm smaller scale neighbours. In order to work around this, designers of new houses will need to carefully work the section of the house to accommodate building regulations, escape windows, safe sill heights and so on, while bringing the eaves level as low as satisfactory window proportioning will allow.

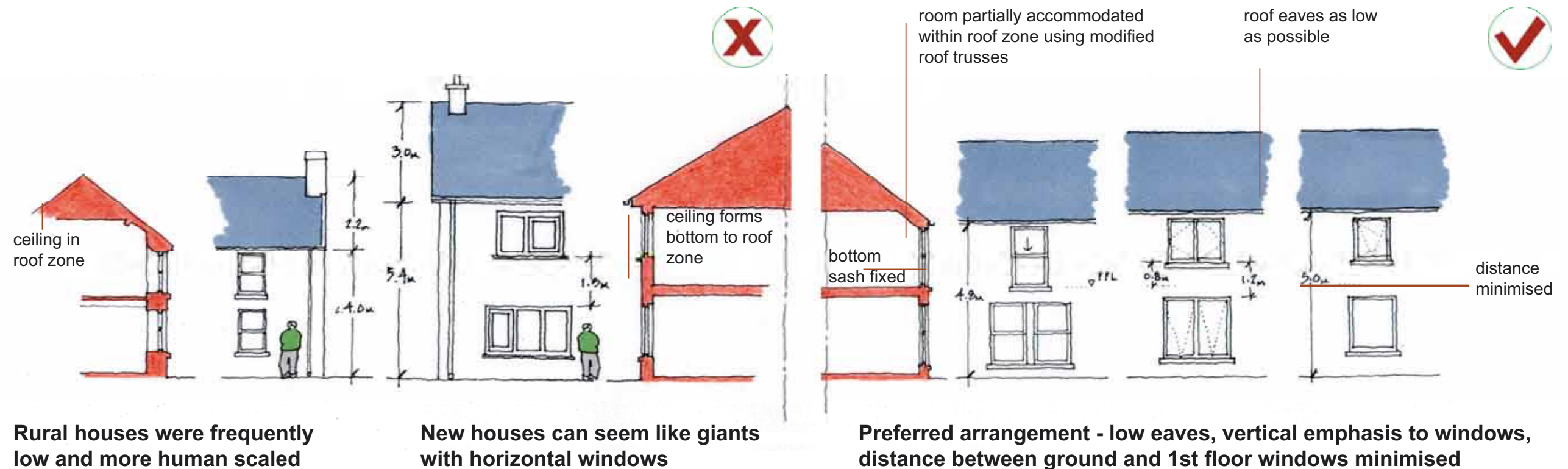

Rural houses were frequently low and more human scaled

New houses can seem like giants with horizontal windows

Preferred arrangement - low eaves, vertical emphasis to windows, distance between ground and 1st floor windows minimised

Cork County Council has made a representation to the DOE to have these amended in line with UK regulations, which permit better proportional relationships to be achieved. Using the current Irish regulations the designer should try to minimise the distance between the top of the ground floor window and the sill of the first floor window to achieve more favourable proportions.

scale

Scale is one very important aspect of proportion: the size of something relative to what is around it. It can be the size of a house relative to its site, the size of a house relative to those in the vicinity of that house, or the size of a conservatory or door relative to the type of house in which it is placed. When designing new houses in the countryside, designers need to be aware of the appropriate 'scale' of their building while at the same time still incorporating all necessary modern comforts and building regulations requirements.

- A characteristic of vernacular buildings is their human scale. The size of the door openings, eaves height and first floor ceiling height all feel more closely related to the size of the person. For many this is what gives them a great charm;
- It is more frequent today for new rural houses to be 'out of scale' with their surroundings. This is because they are bigger in terms of floor area and heights, without any measures being taken to reduce their scale;
- The scale of a new dwelling in the countryside is perhaps the key element in design consideration. It is extremely important to ensure that the building's size is relative to its surroundings. As a general rule, the larger the dwelling, the greater the impact;
- A large dwelling, regardless of single or two storey, will appear awkward within enclosed landscapes or within an area characterised by small field patterns;
- A large house needs a large site and that site needs to be set within a large scale landscape. In other words, a landscape where the views are long and there are mature landscape elements that have greater prominence than the house itself. The house should be reduced in size by being broken into smaller elements;
- It is quite simply bad manners to place a large scale new house beside an existing small dwelling, as this may result in overlooking and invasion of privacy. Be conscious of the impact your new house will have on neighbouring buildings.



A large new house out of scale (and keeping) with its neighbours
(adapted from Moray District Local Plan 1993-98: Housing in the Countryside)



Landscaping absorbs the size of the house



Size of windows & doors make this building seem smaller - human scale



A large house looks completely out of proportion on a small, open site

A large house requires a large site

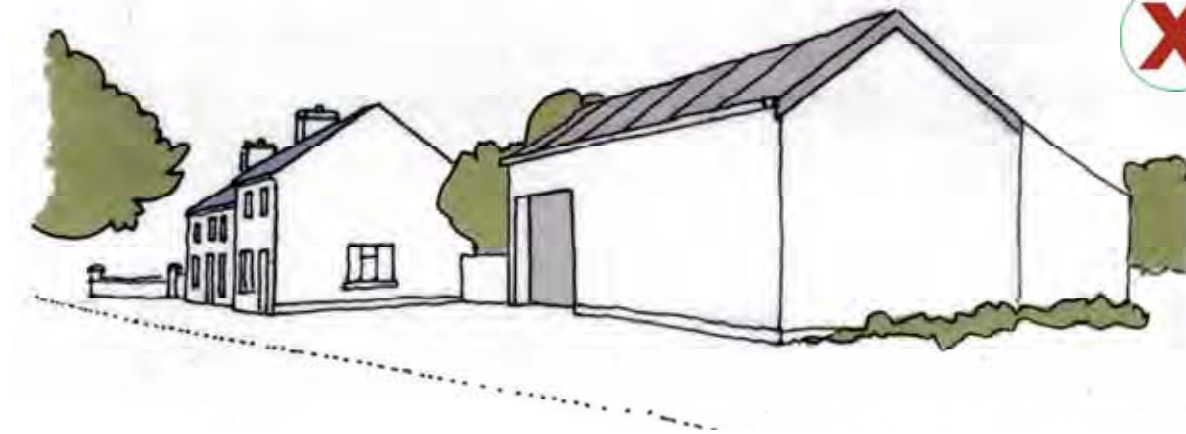

Absence of windows & large scale door make this building seem bigger
Windows & doors also give buildings their sense of size
 (both buildings in foreground exactly same size)

Satisfactorily scaled dormer with roof



Poorly scaled dormer with roof



2 dormer elements, identically sized
but very different scale relative to respective house

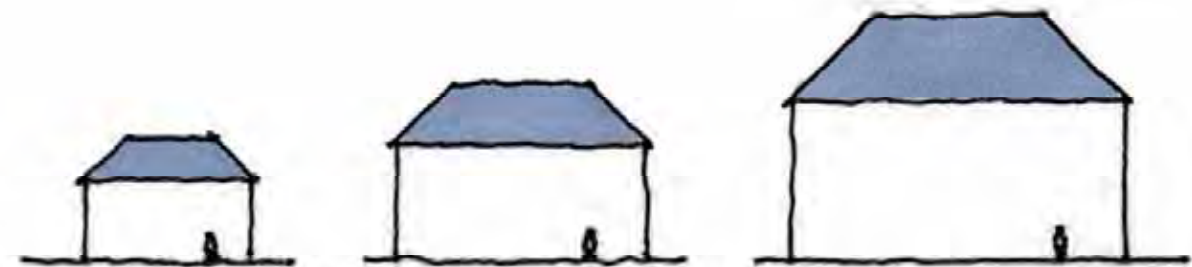

3 Houses identically proportioned in terms of height to width etc. but very differently scaled

form

familiar building forms in the countryside

Single Storey

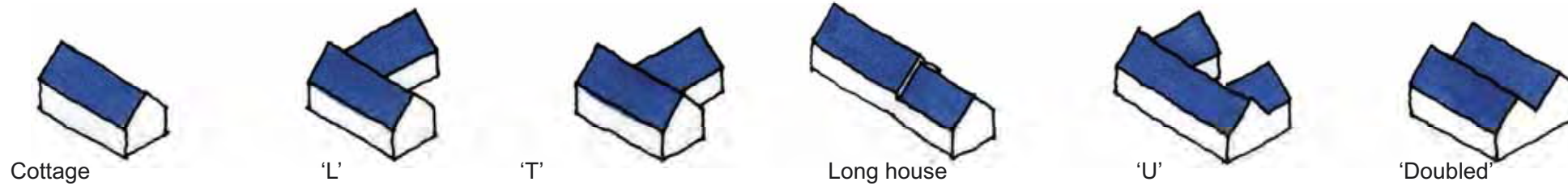

characteristics to retain

- Low eaves
- Narrow plan
- 35-55° roof pitch
- Modest scale
- Vertical emphasis to gables
- Sturdy and solid
- Natural finishes
- Flat fronted
- Well-mannered

1 + Half Storey



Two Storey

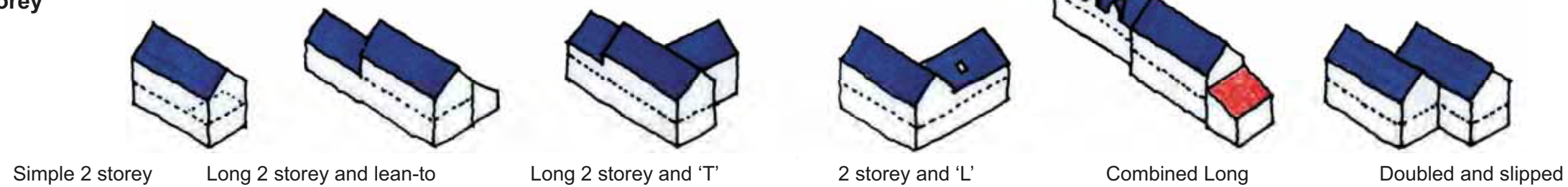

Hipped

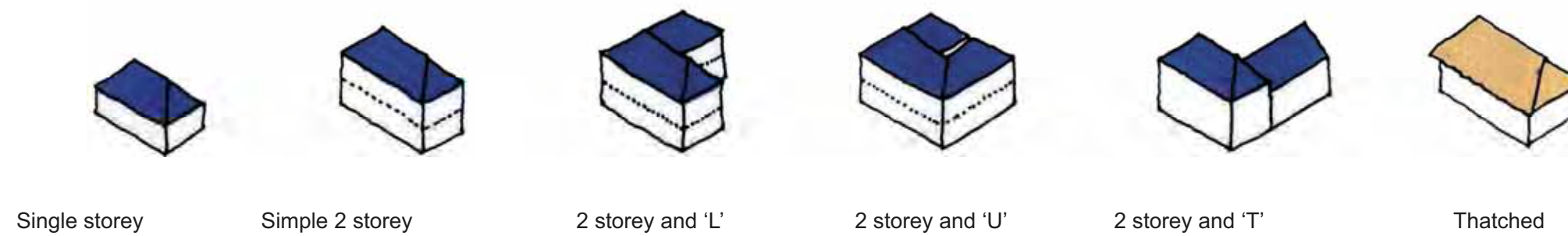

Other Miscellaneous Forms

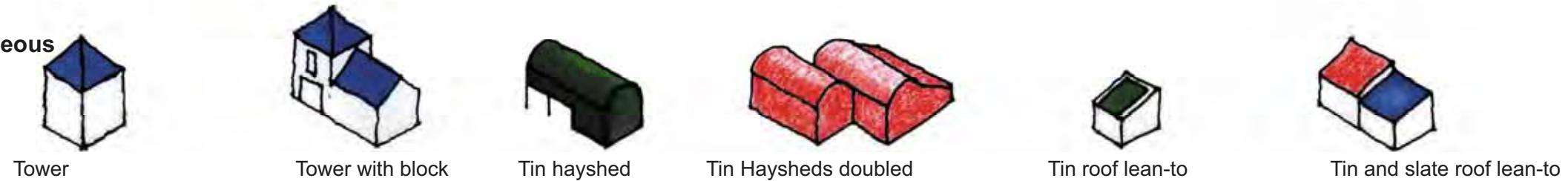

pattern book forms, alien to the countryside

Odd Miscellaneous Shapes/Forms

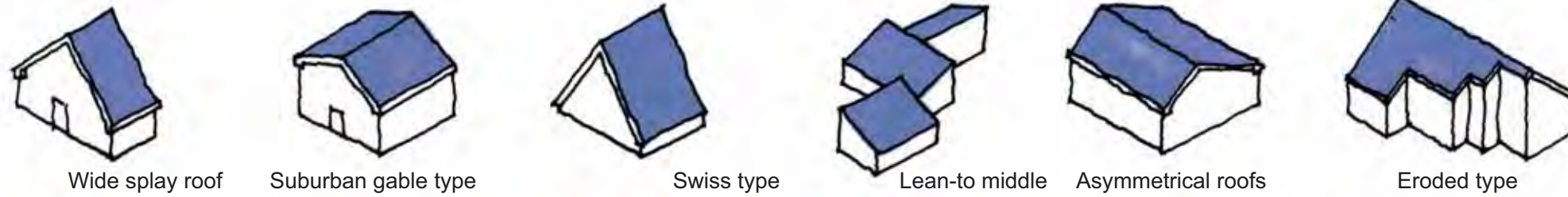

characteristics to avoid

Single Storey

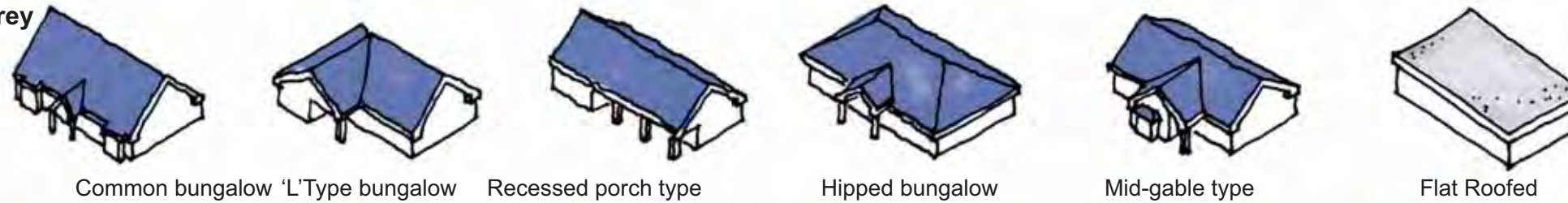

- Highly modelled
- High eaves
- Wide gables
- Low or no roof pitch

1 + Half Storey

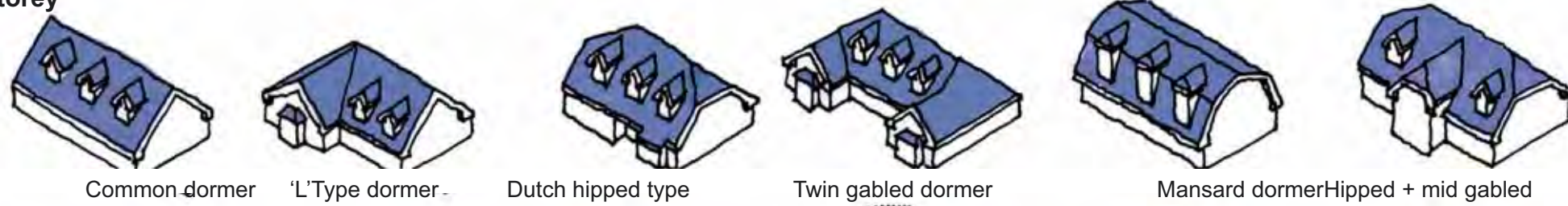

- Bulky and squat
- Awkward scale
- Synthetic finishes

Two Storey Gabled

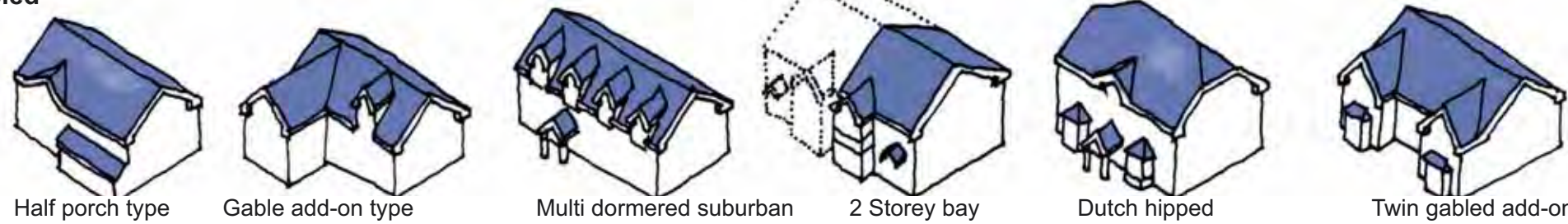

- Plastic clad
- Decorative frontage
- Many additional details

Two Storey

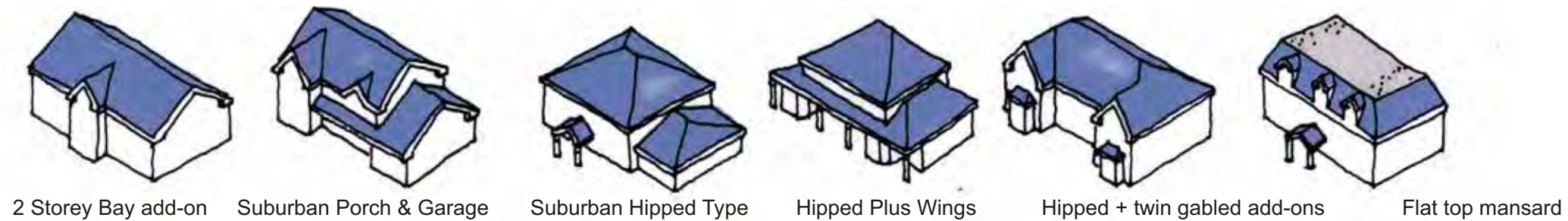

the problem: bigger, higher, wider

the problem with house sizes today

Cork cottage: Simple form, narrow widths, steep roofs, vertically proportioned windows, central chimney at gable, natural local finishes

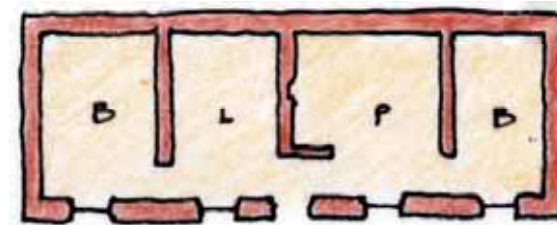

Typical Cottage - Linear Plan organisation

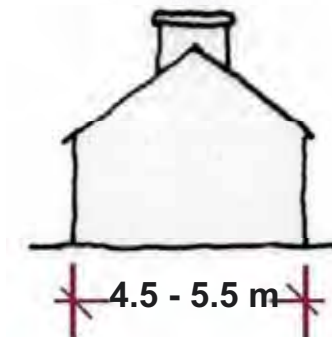

The 70's bungalow: Wide plan - dark central corridor, shallow pitched roof, horizontally proportioned openings, imported synthetic finishes.

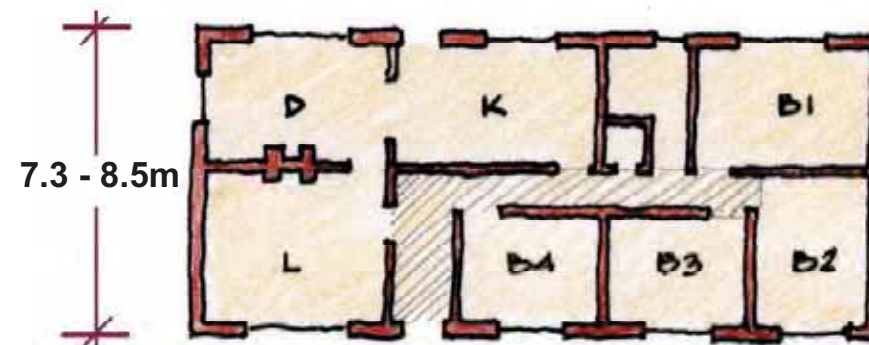

Typical Bungalow - Double room depth internal corridor

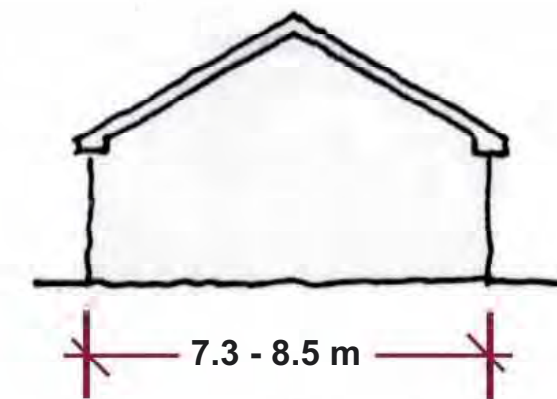

The 90's 'big house' - Double deep plan, bulky proportion, off centre chimney, shallow roof pitch, adorned frontages, mid-roof dormers, large roof spaces, cluttered finishes.

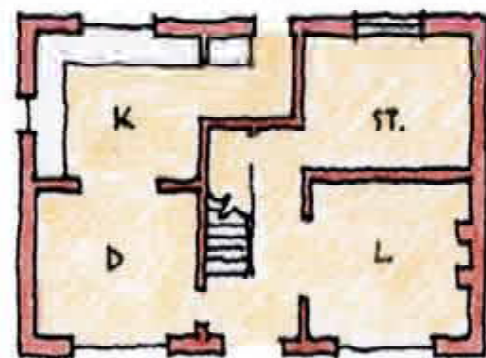

Current Composition
Double room depth plan

gives →



Unsatisfactory 1 1/2 Storey

or →



Suburban 2 Storey Type

or →

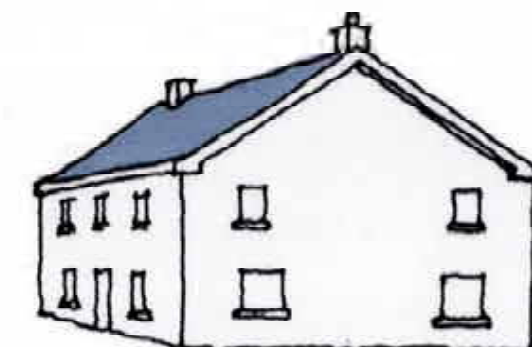

Unsatisfactory "Traditional" Copy

one solution - break down the bulk, get the massing right

Modern pattern book houses differ radically in form to those more familiar buildings of the countryside. It is an issue of bulk, size and scale - big houses, wide gables, deep plan forms, squat and 'overweight'. Massing is about how you assemble the elements of the house - in one big bulky overweight mass, or in an assembly of more slimmed down elements. Solutions lie in breaking down massing using 'traditional' better proportioned forms.

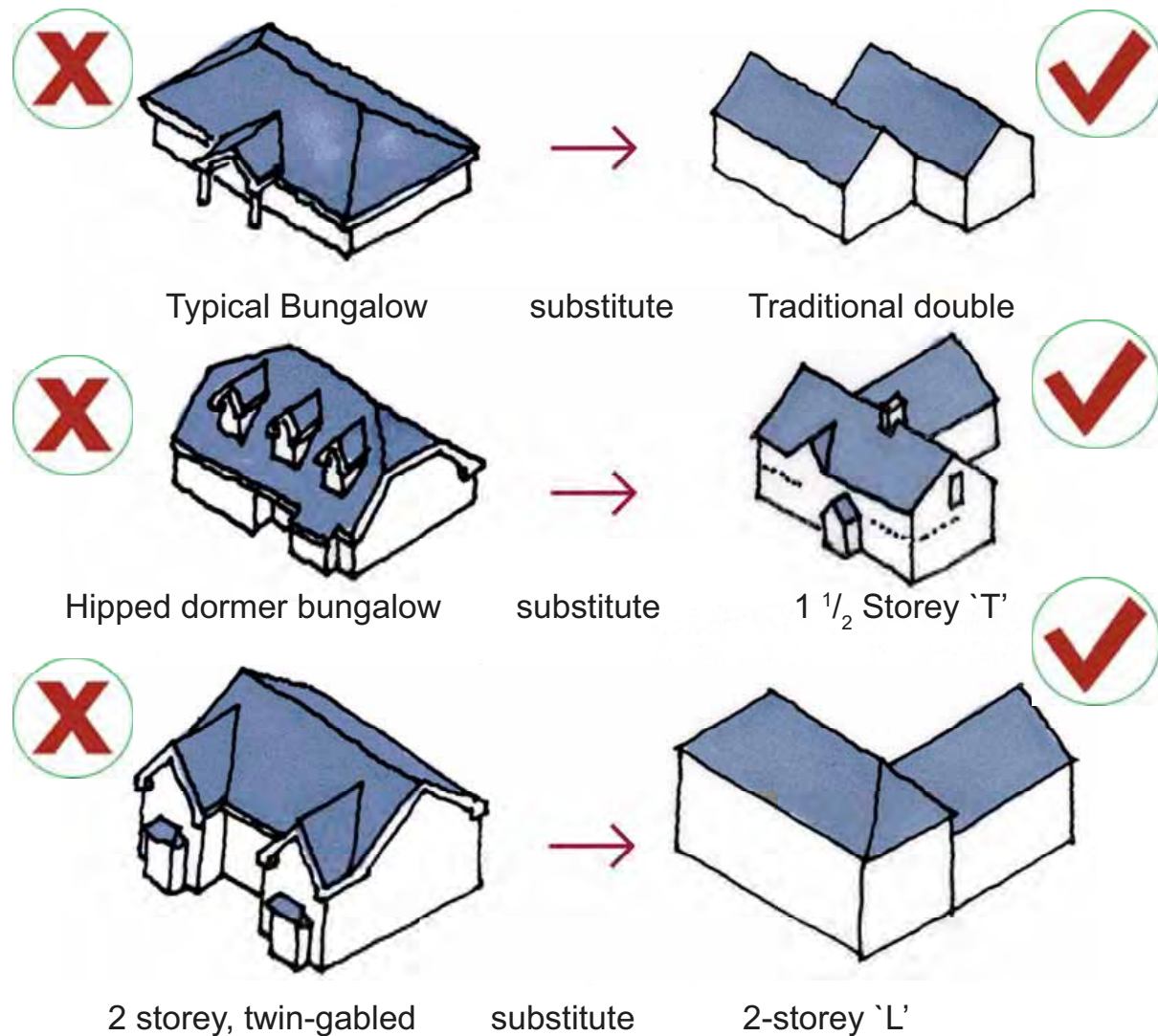

Substitute bulky houses with traditional forms to obtain better massing

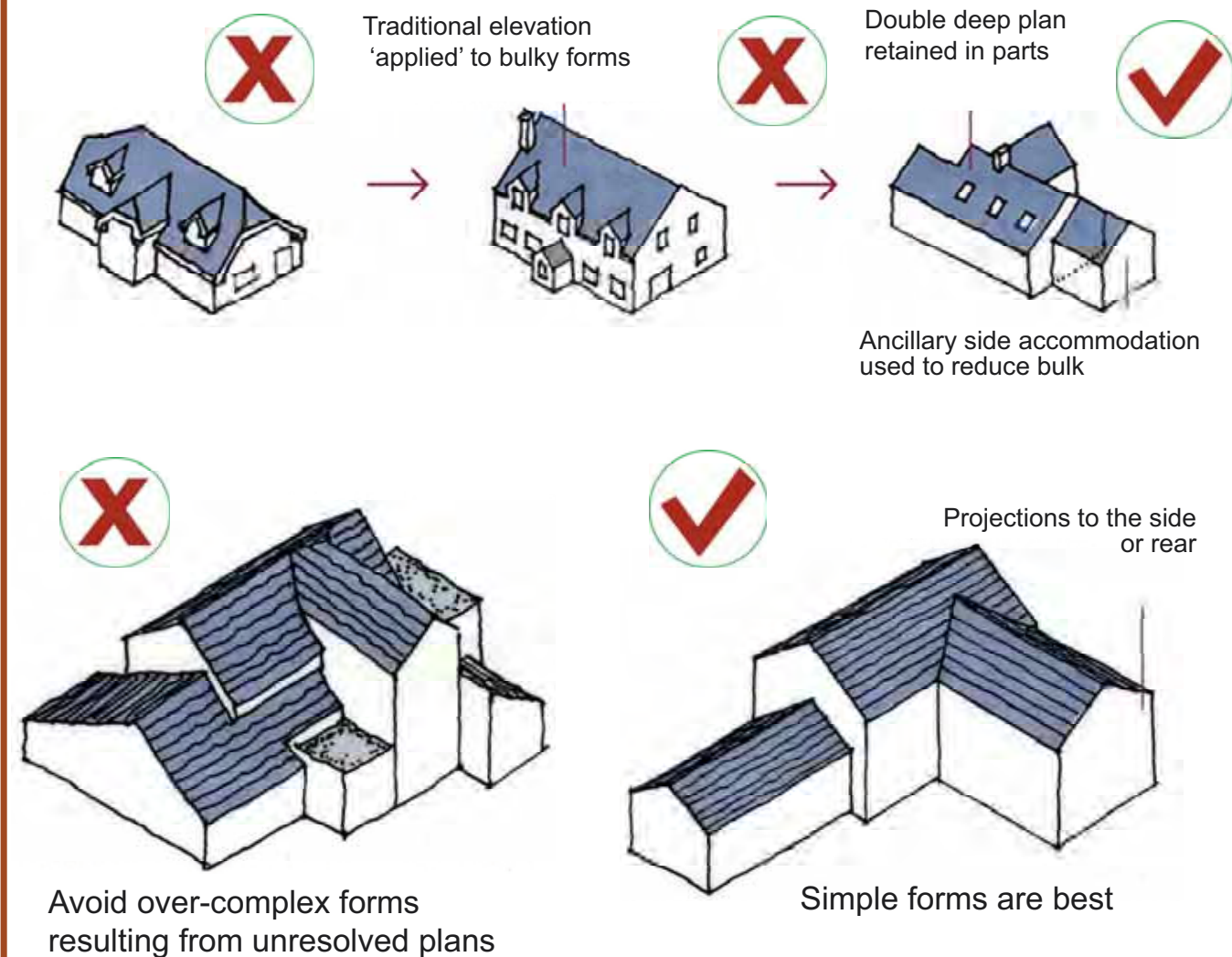

Guidance also seeks to avoid poor substitution

the narrow plan form ... some advantages of ...

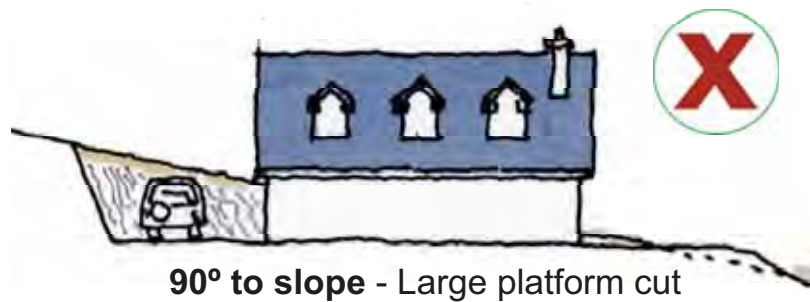

DOUBLE ROOM DEEP PLAN - Inflexible on slopes

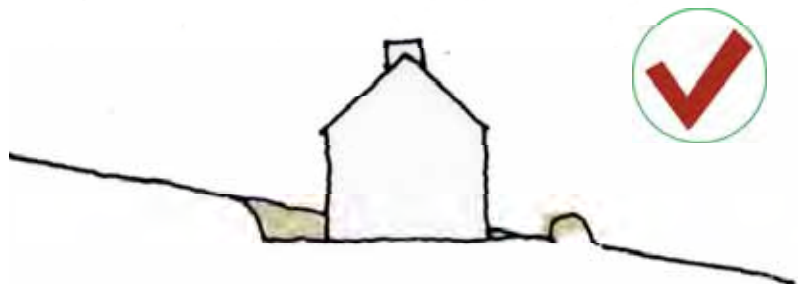

NARROW PLAN - Parallel with slope - narrow depth reduces cut

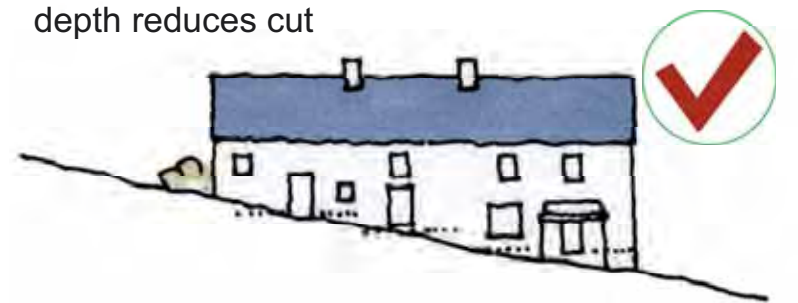

90° to slope - absorbs level changes

1 Building on a slope is easier

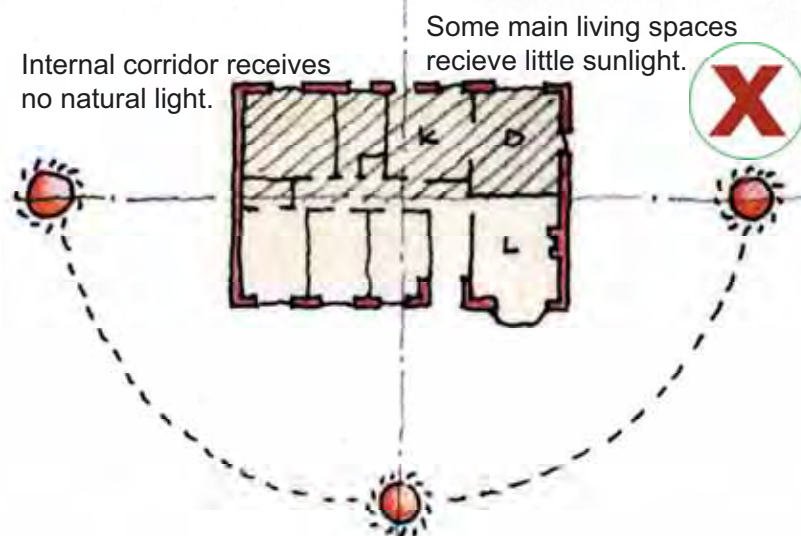

DOUBLE ROOM DEEP PLAN - 50% of house does not benefit from solar

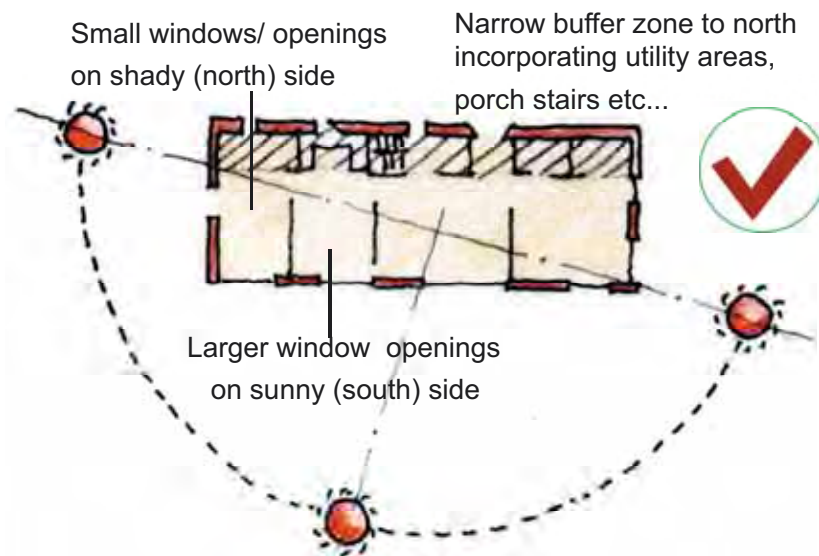

NARROW PLAN - Preference for house to face south east, if possible, to maximise on heat gains in winter & reduce over heating problems in summer.

2. Heating costs can be reduced by 30%

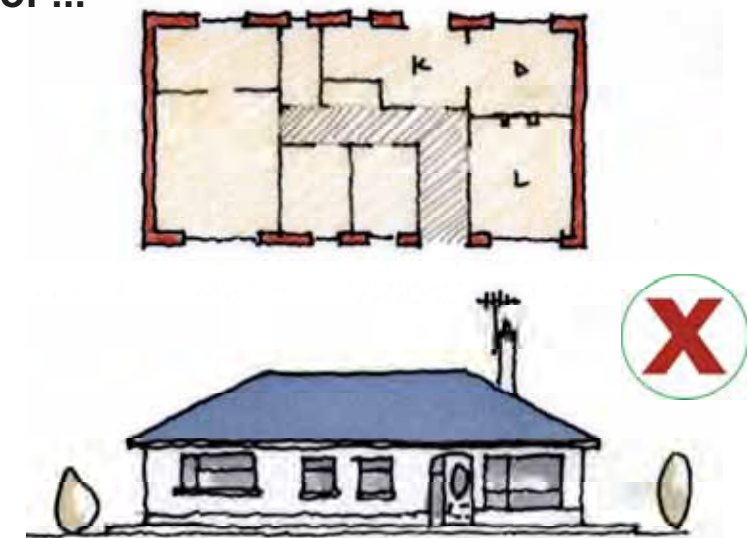

DOUBLE ROOM DEEP PLAN - typical plan layout with internal corridor places constraints which dictate the size and location of windows resulting in too much glass in relation to masonry.

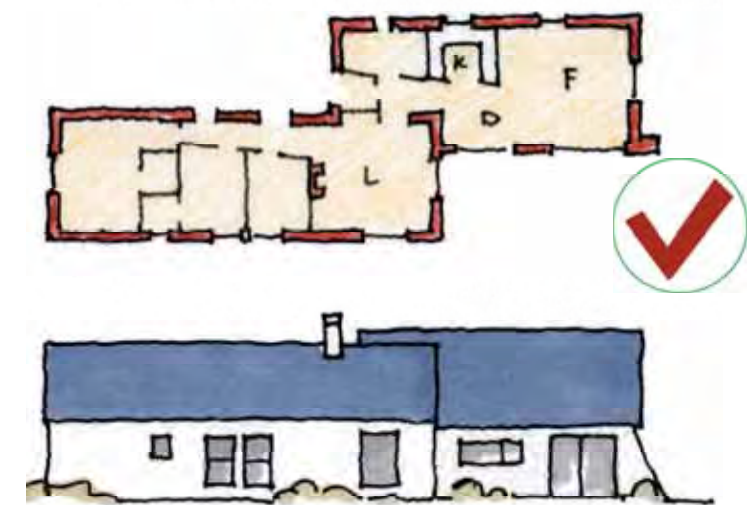

NARROW PLAN - plan facilitates window glazing options. Leads to more satisfactory ratio of glass to masonry. Greater freedom in composition.

3. Breaking away from double deep plan allows better balance of glass to masonry

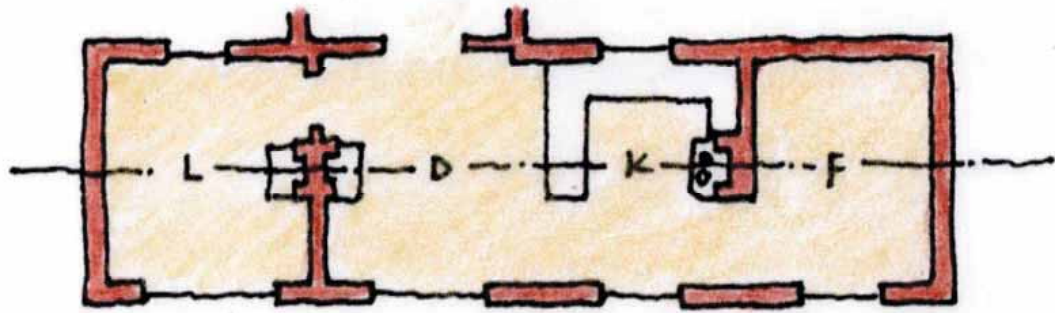

Contemporary open plan within traditional form



Contemporary house with traditional form. The narrow plan house avoids the need for excessively tall, or shallow pitched roofs.



Extensions and additions should be directed to the gable end or rear elevation



The narrow plan form reduces the need for an excavated platform. The house elements are broken down and follow the contours

Spatial Diversity - Departing from the double deep plan facilitates spatial interest. These dynamic and contemporary interiors are based on the narrow plan form.

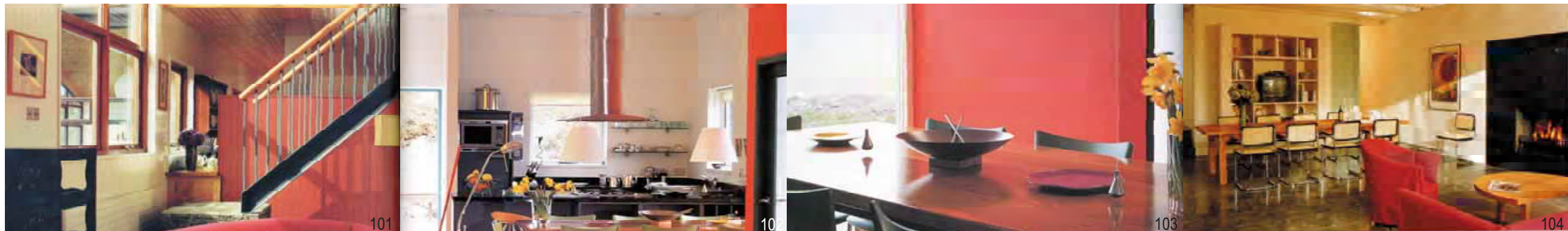

the deep plan form in a rural context

As seen earlier, the double room depth plan is the format used for most new rural houses today, due to efficiency in maximising rooms under one large roof. The consequence of this however, is that new single and two storey houses tend to be at odds with our Cork vernacular. Here we examine reworking a typical double deep house, whilst still maintaining a similar number of rooms, area and other efficiencies. On this page a 12.2m (40') x 9m (30') plan footprint is maintained, while a better proportioned houses is achieved by using traditional gable dimensions with lean-to roof and other modifications.

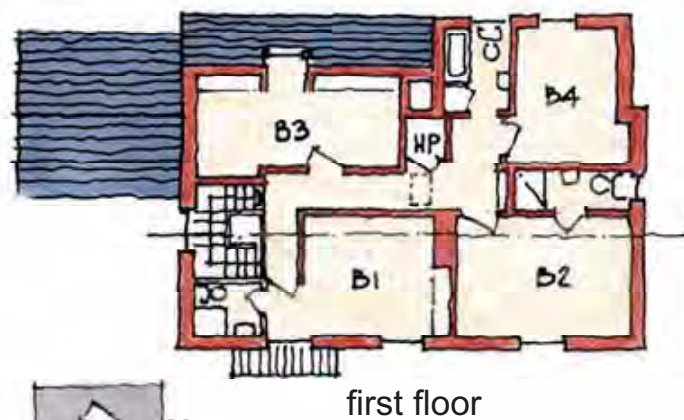

first floor

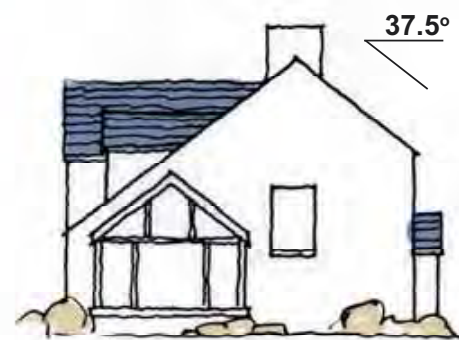

south



east



north



west



part of the same family - using traditional gable dimensions a deep house plan can complement its simple forebears

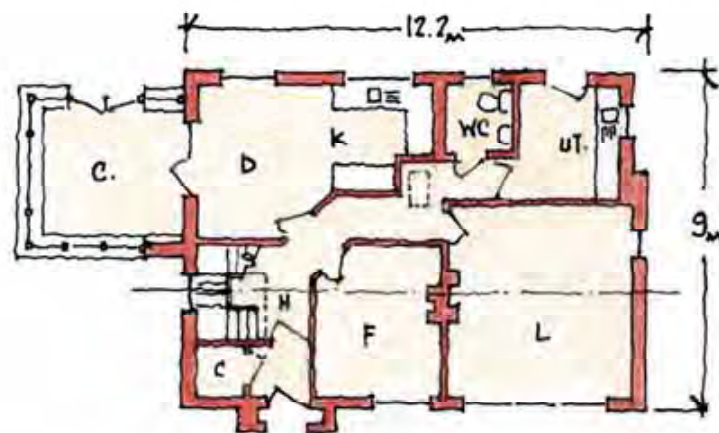

ground floor



west (rear)



north



south



east

larger variant

2 Storey House - 180 m² or (1940 sq ft) plus conservatory

alternative traditional types

The problem presented by the double room deep plan house type within the Cork countryside is essentially one of form and scale. The typical roof form generated by this plan type is an overly dominant feature of such houses. Combinations of hipped roofs and deep overhanging eaves exacerbate the problem and result in over sized and out of scale roofs. These examples show that elegantly simple rural house designs can accommodate the double room depth footprint (12.2m x9m, or 40' x30'), yet remain faithful to Cork's heritage. These will sit better in the countryside than most patternbook designs. As with the example on the facing page, this example uses traditional gable dimensions with a rear lean-to roof. Whilst not advocating that all new houses should be traditional, this illustration serves to demonstrate that good proportioning is possible for larger houses. A more contemporary and innovative interpretation of the deep plan form is explored in the Appendix of this document by Mary Kerrigan Frank Harkin Architects.

If well detailed, these types would be more suitable than most pattern book models for those who do not wish to employ a designer.

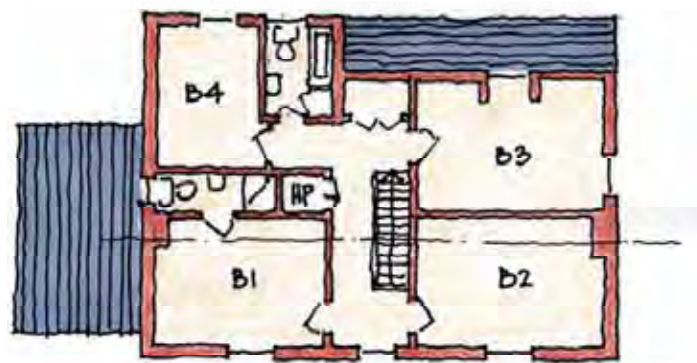

first floor



side



simple central chimney



eaves dormer with bay windows



single eaves dormer



thin eaves dormer with porch

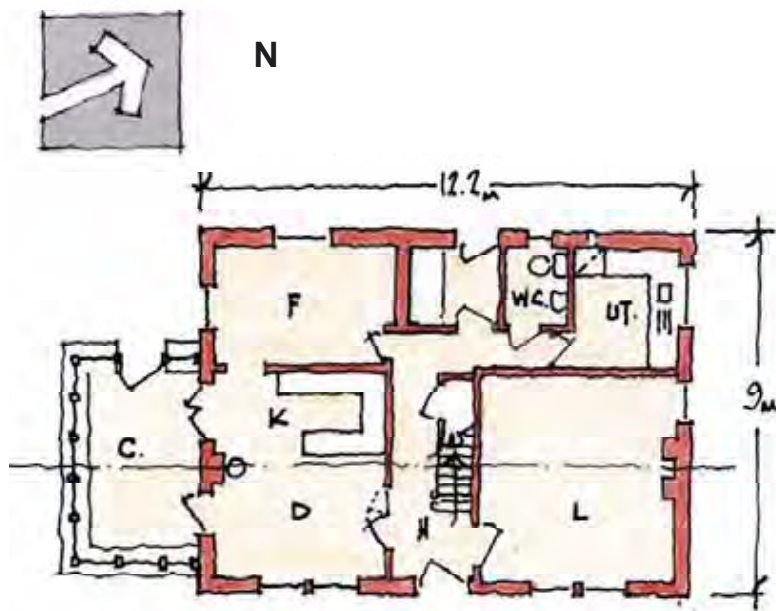

ground floor



part of the same family

c.1870 mm high sash, top opening escape, bottom sash fixed

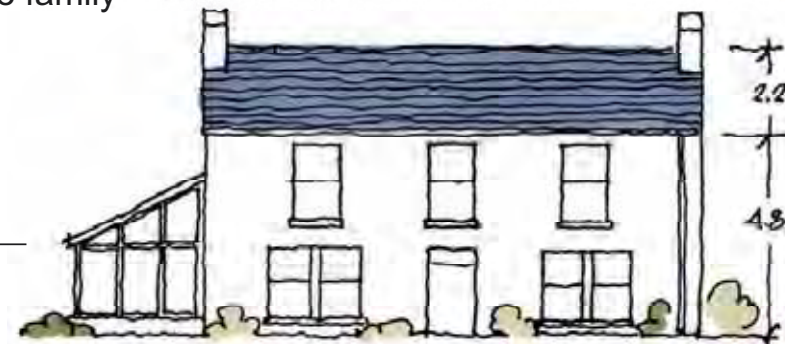

front

2 Storey House - 186 m² or (2000 sq ft) plus conservatory

variants of the same plan



summary & checklist design

have you:

Developed a house that is simple in its form - is the form related to rural building forms of Cork?

Designed a house that incorporates distinctive characteristics of its location within rural Cork?

Achieved attractive proportions in the building design?

Developed a plan which will allow a good solid-to-void relationship in its windows and doors?

Ensured the house is in scale relative to:

its site - does the choice of single or two-storey respond to the character of the site?

surrounding buildings - is the scale appropriate to the existing character of the locality?

Broken down the massing of the house to articulate different elements in order to reduce its bulk where necessary?

Opposite page: Castlepark, Kinsale - a superb study of form, scale, proportion and detail. A notable feature of Castlepark is the way in which the architect achieved a very high solid-to-void relationship (i.e. large areas of masonry) whilst at the same time managing to incorporate large glazed openings carefully balanced by use of rooflights.



part four good construction

- Elements:
 - Roofs
 - Chimneys
 - Windows
 - Dormers and Rooflights
 - Doors
 - Porches and Canopies
 - Conservatories and Sunspaces
- External finishes
 - Stone
 - Colour
- Summary & Checklist

* This guide does not address **building regulation** matters. Designers should satisfy themselves that fire safety and building regulations requirements are met.

This may require specialist expertise in some cases.



good construction

This section is devoted to design detail and construction to focus attention on a range of critical design elements frequently overlooked but which are fundamental to the successful appearance of our new rural homes. These elements are only relevant once the issues of proportion, scale, massing and form have been successfully tackled. The section deals with issues that appear straightforward but are often mishandled, poorly constructed or result in clumsy and The section deals with issues that appear straightforward but are often mishandled, poorly constructed or result in clumsy and ugly detailing.



Opposite page: rough cast render applied to surface of building can have a striking effect and protect the structure from the elements.

roofs

- slate, tiles, metal sheeting, thatch, glass, zinc

A roof lends a building its distinctive profile. Roofs of Cork rural houses tend to be simple shapes: hipped or gabled, and generally sloped 35° - 55°. Other shapes are of course possible, but only where they are conceived with skill and will be executed with care. The interesting and colourful roofs of Cork rural buildings contribute to the striking architectural characteristics of many local areas. The material used for roofing is an important aspect of local architecture, both functionally and aesthetically.

- Blue grey slate, thatch and painted corrugated sheeting are traditional rural Cork roofing materials;
- The way the roof edges are constructed is critical to the successful appearance of a house. Today almost 100% of new houses are constructed where the roof sits as a 'lid' oversailing the external walls. More often than not these are finished in white PVC, a detail that, perhaps more than any other, sets them apart from our rural vernacular context. Traditional rural roof edge details that are low maintenance can be easily achieved today, using painted plaster or dark coloured PVC. This gives new houses a more immediate direct connection with neighbouring buildings and maintains regional identity - something which Cork County Council is anxious to actively encourage;
- With the exception of the occasional Victorian house or ornate gate lodge, the edges of Cork rural house roofs tended to be very simply treated. For this reason scalloped or ornate fascias are generally to be avoided;
- Care is also required with thick format roof tiles; these are more suited to large simple roofs only. Small format roofing tiles/slates are the best material for smaller roofs, such as bay windows, dormers, porches, etc.;
- Simple black round plastic rainwater goods are recommended. These have the advantage of attractive lines reminiscent of cast iron, are very economic and do not easily show grime and dirt over time. White plastic or square section rainwater goods, on the other hand, have few of these features and should generally be avoided. They also require regular maintenance, which they rarely receive, to avoid becoming grimy in appearance;
- Higher statutory insulation standards for dwellings will mean thicker roof construction build up. Great diligence and skill will be required by designers and house builders to reconcile heat loss issues with attractive detailing.



1 Minimal Eaves and Verge
 Slate continues very slightly over gable, with or without propriety edge trim
 Tiles too thick for small roof
 Conc / plaster carried over gable
 Slight projecting eaves in blockwork and plaster
 Black round rainwater goods

2 Slight Projecting Eaves & Verge
 Slightly raised plaster band (see photo)
 Plastered eaves projection formed with corbeled blockwork or concrete
 Stained or painted timber or dark coloured P.V.C.
 Soffit recessed well above verge board
 Simple sloped soffit runs along eaves

3 Coped Gable

4 Oversailing Roof - Limited use preferable

Simple fascia / soffit
 Unattractive 'boxy' fascia / soffit
 Small Roofs
 'Busy'
 Suburban Multiple Oversailing Roofs

Shallower pitch

Mono Pitch - Slate **Mono Pitch - Tin**

Gable - Slate **Gable - Tin**

Hipped - Thatch **Hipped - Slate**

Pyramid - Slate **Curved - Tin**

Cork roof shapes & materials

40° 45° 35°

Common roof profiles

Flat 60° 25°

Flat **Ecclesiastical** **Shallow**

Exceptional profiles
 - very high design quality required

Gable roofs - preferred rural roof edge treatments, without white PVC

Avoid box verges **Avoid heavy lid** **Avoid box eaves**

chimneys

Chimneys are a very important element of a house, much overlooked today. They have the potential to add substance and presence to the appearance of a house. Poorly positioned, meanly built, or a total absence of, chimneys can detract enormously from a house.

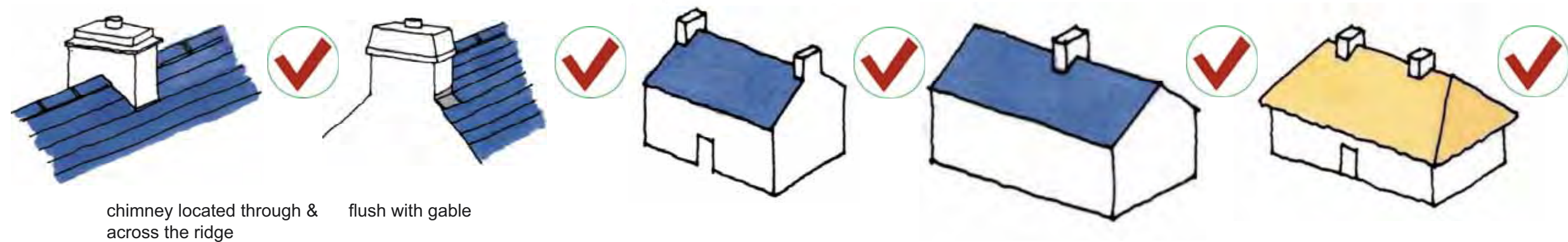

Chimney stacks add interest to a house and as a general principle for rural houses they should be located through and across the ridge. Where chimneys are located at gables, they should preferably be flush with the face of the wall, as is a feature characteristic across most of Cork. In East Cork, however, stout stacks built proud of the gable are a feature typical to the area.

Care and attention is required with the detail and construction of chimneys and cappings. Rural chimneys tended to be strong elements, whereas today they can often appear narrow and weak. The requirement today for passive flue vents to internal bathrooms and toilets and below slab radon sumps gives reasons for chimneys to incorporate several flues. Capping details vary across the county, giving local identity. Whilst thin ("mean") chimneys are to be avoided, heavy or clumsy detailing of chimney cappings can be equally unsightly if care is not exercised.

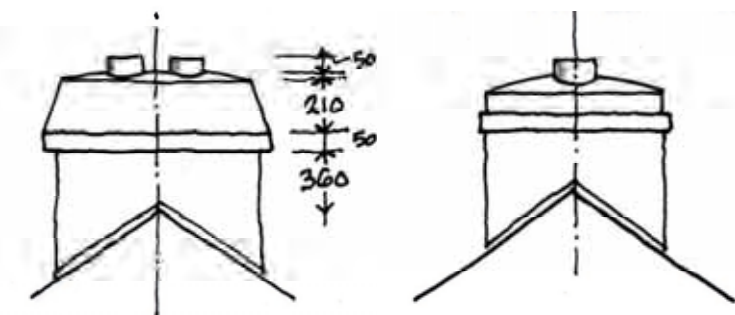



Avoid tall, spindly types positioned on the pitch of the roof as per the examples set out above

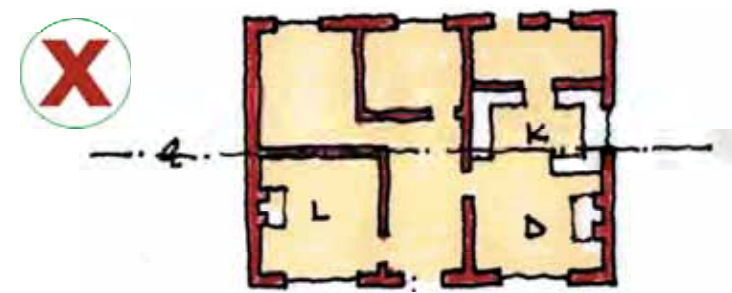

Layout A - results in spindly type chimneys positioned on the pitch of the roof.

gives →

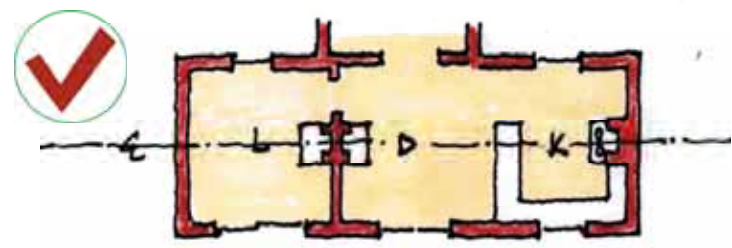

Layout B - provides for a centrally placed chimney.

gives →

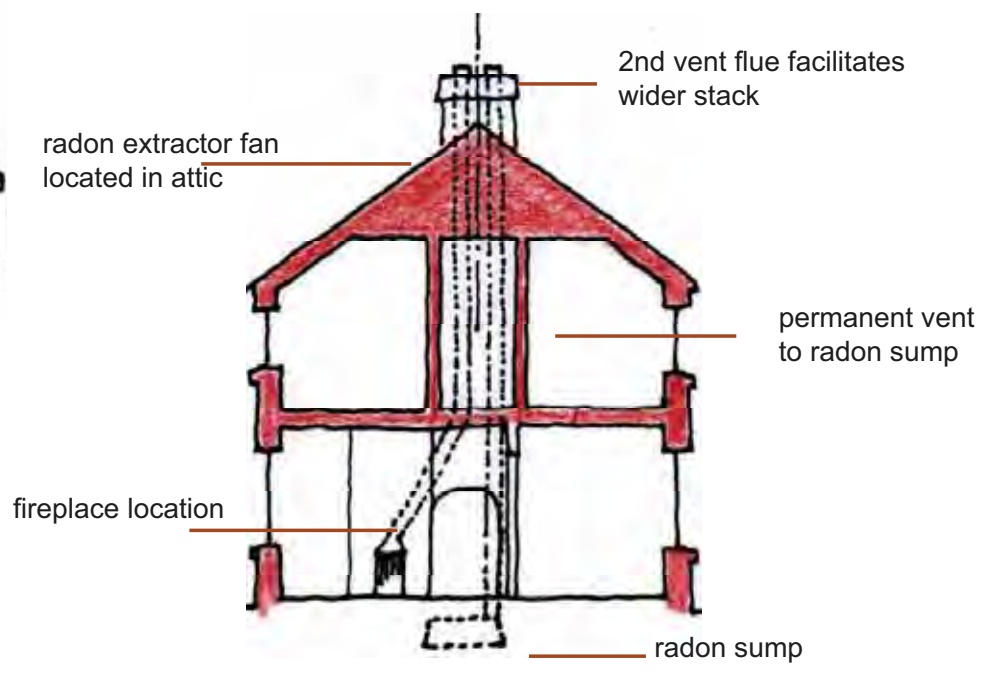
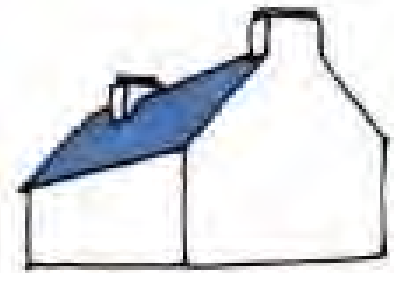

The plan layout of a house affects the position of chimneys

Offset fireplace remedy



128



129



130



131

windows

size, shape and arrangement of openings

All houses require natural light and therefore need openings. Being the predominant openings of a building, the size, shape and positioning of windows significantly influences the scale and proportions of the dwelling. Windows are perhaps the most difficult aspect of houses to get right. In the past, size and shape was limited by construction materials and costs, which meant that window openings tended to be small and away from corners. Consequently openings were surrounded by large areas of solid wall creating what is known as a high 'solid to void' relationship, giving a strong and sturdy appearance to our rural buildings. Today there is no such constraint. Current practice is to use an increasing selection of larger, wider windows with a variety of shapes, often with unfortunate consequences and which tend to look at odds within the much simpler rural setting.

Naturally brightly lit interiors are desirable and for any room to be adequately lit, the area of glass should not be less than 10% of the floor area. It is worth noting that highly glazed façades are possible in certain locations provided they are conceived with skill and executed with care, using attractive framing materials.

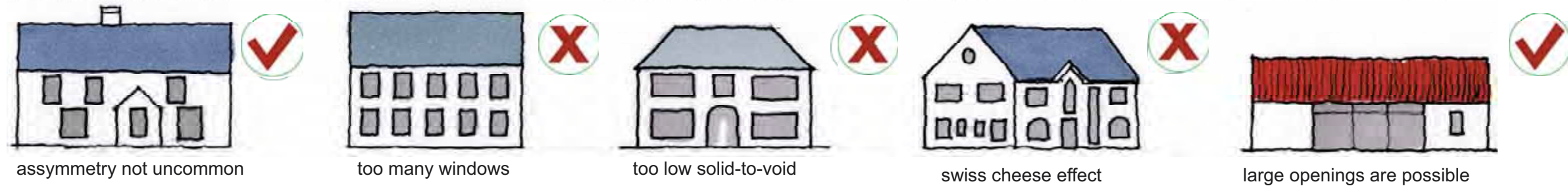

Simple guidance on window openings might be summarised as follows:

- Keep the range of opening sizes to a minimum and the shape of openings simple. Arrange openings in order to maximise a high solid-to-void appearance where it matters - i.e. work the plan to limit the number of openings in some places, using rooflights and concentrating large openings to the main living areas which ideally will have the most sun and view, remembering that highly glazed façades are often best located where they are not fully in public view;
- Keep the arrangement of openings simple, observing the central axis generated by the shape of the wall. This axis is particularly strong and demands more attention where pitched roof shapes are used, such as with gable ends or dormers;
- Vertical emphasis of openings is generally preferable to horizontal emphasis;
- Windows should be centred either exactly on the axis, or purposefully off the axis. Openings slightly or equally off the axis are very discordant in appearance. Dormers, rooflights and first floor windows are traditionally centred over ground floor windows. As a general principle these should not be bigger than the lower level windows.





vertical emphasis



classical



high solid-to-void



simple

Cork Rural Context

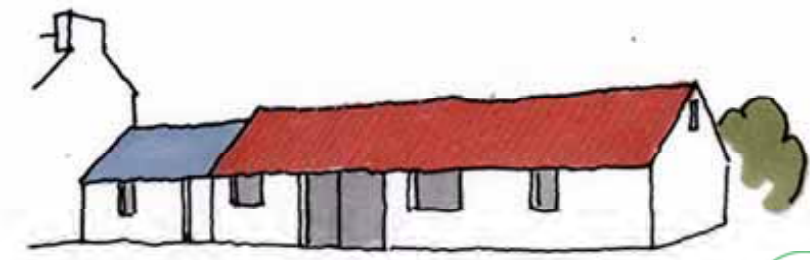

large opening in outbuilding

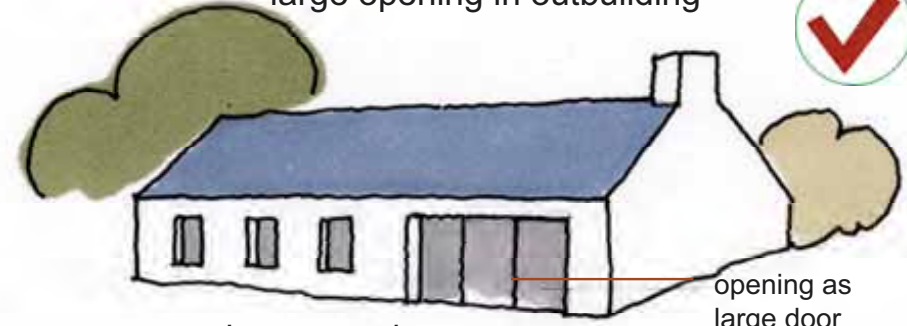

large openings
Balancing Large Openings

opening as large door



typical bungalow - horizontal windows

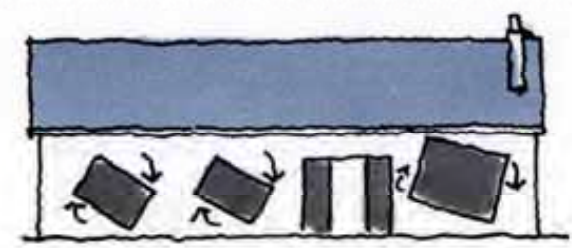

rotate openings 90°

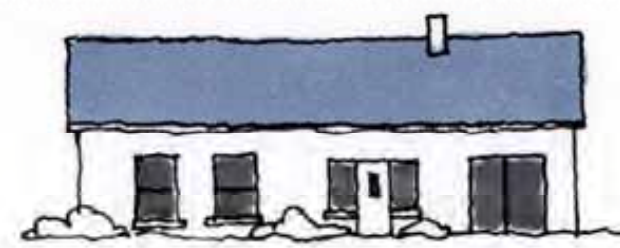

higher solid-to-void effect

Vertical Openings Appear Appropriate

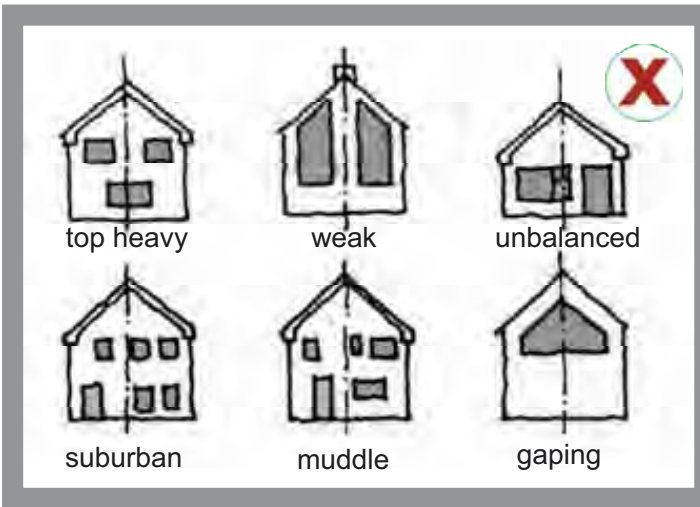

top heavy

weak

unbalanced

suburban

muddle

gaping

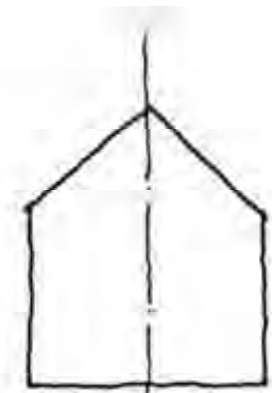

pitched form creates strong axis

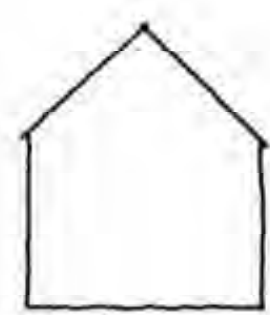

no openings - strongest

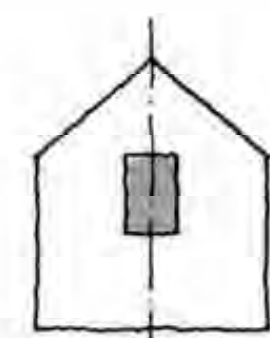

centred - not too large



deliberate off-centre

Openings in Gables

windows

proportion, division and materials

Windows are one of the most important features of a building; the choice of window style affects the visual personality of a house. Depth of profile, elegance and proportion in windows needs to be considered as windows can weaken the elevation if set too close together, or too close to the corner. Today, windows frequently receive little of the care and attention to proportion and construction they were assigned in the past. Well made, attractive windows can hugely enrich a building. Similarly poor window design, or cheap-looking window construction, often spoils the appearance of an otherwise satisfactorily designed new home. Window design should maintain proportion and simplicity.

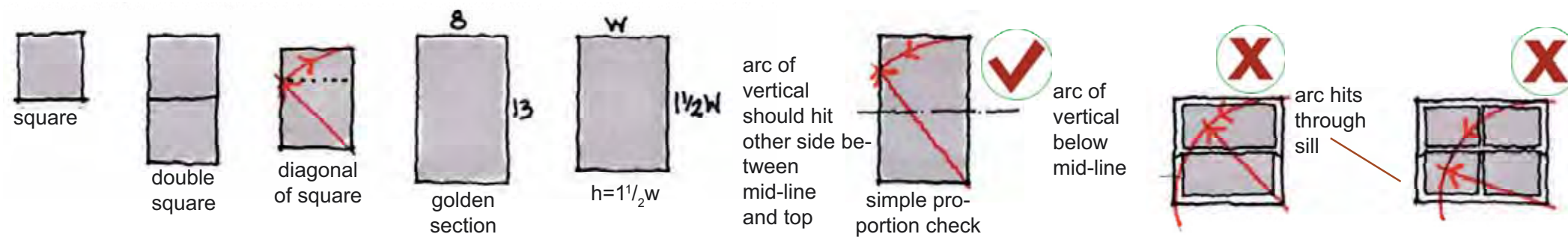

Proportion and Vertical Emphasis: Simple Rules of Thumb

Windows do not have to be small to respect tradition. Larger windows can offer spectacular views, but the length to width ratio needs to be considered. In many cases, a series of smaller windows with vertical emphasis, or of square proportion, sit more comfortably than large horizontal openings. A number of methods can be employed to integrate larger windows into rural buildings as depicted below.

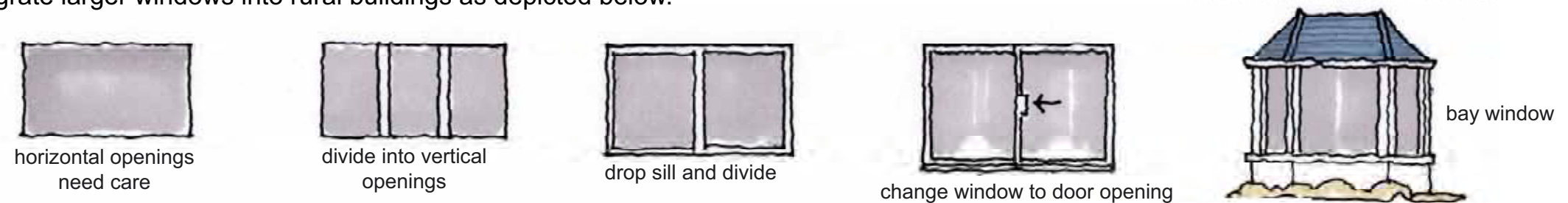

Ways to Incorporate Horizontal Openings in a Rural Context



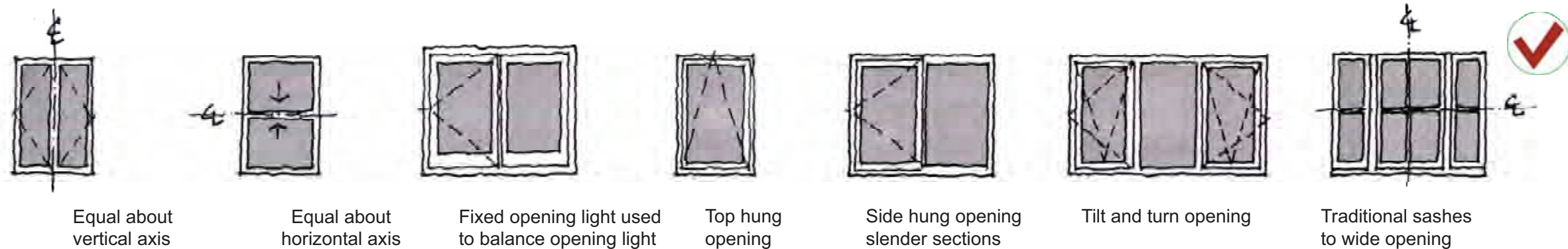

Equal about vertical axis

Equal about horizontal axis

Fixed opening light used to balance opening light

Top hung opening

Side hung opening slender sections

Tilt and turn opening

Traditional sashes to wide opening

Good window division

Good window division is generally based on two principles, the first is to divide the window exactly symmetrically about the central horizontal or vertical axis or sometimes both. The second is to use a window type or system which facilitates division giving glass panes of identical size (or as near as) e.g. vertical sliding sash or similar.

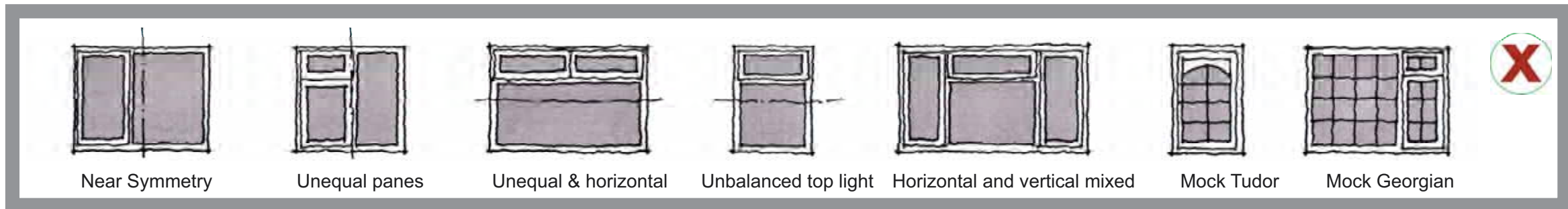

Near Symmetry

Unequal panes

Unequal & horizontal

Unbalanced top light

Horizontal and vertical mixed

Mock Tudor

Mock Georgian

Window division to avoid

Windows should be made out of the best quality materials affordable, both in terms of appearance and performance. Traditionally windows were made of painted timber which has several advantages including freshness of colour, slenderness of sections and depth of profile. Timber joinery craftsmanship is still strong in Cork. Alternatively many firms offer timber window systems which can be factory finished, stained or aluminium clad minimising maintenance. Otherwise windows in metal and plastic are available in a greater range of colour finishes. Some plastic window systems can appear very chunky and two dimensional, especially where false georgian bar strips are used - something which should be especially avoided. Higher glazing thermal performance requirements demand even greater vigilance with respect to many of the above points.

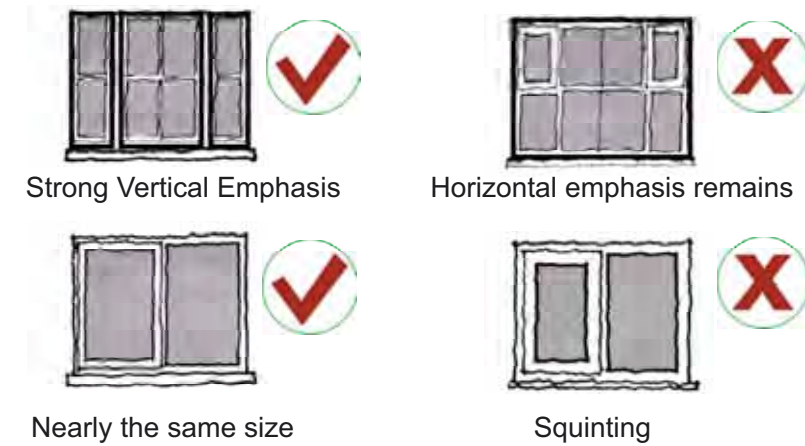

Strong Vertical Emphasis

Horizontal emphasis remains

Nearly the same size

Squinting

Window construction fundamental to design good and poor realisation

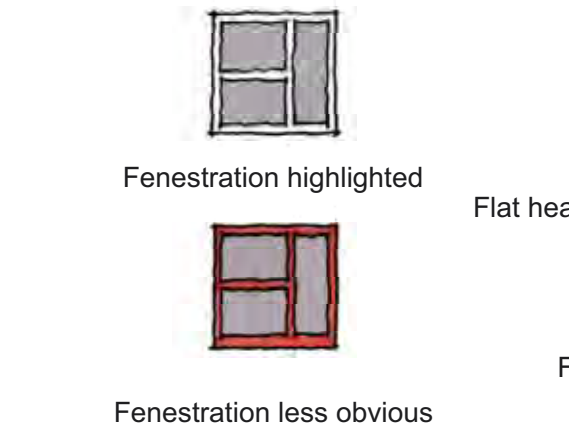

Fenestration highlighted

Fenestration less obvious

Colour: white highlights division

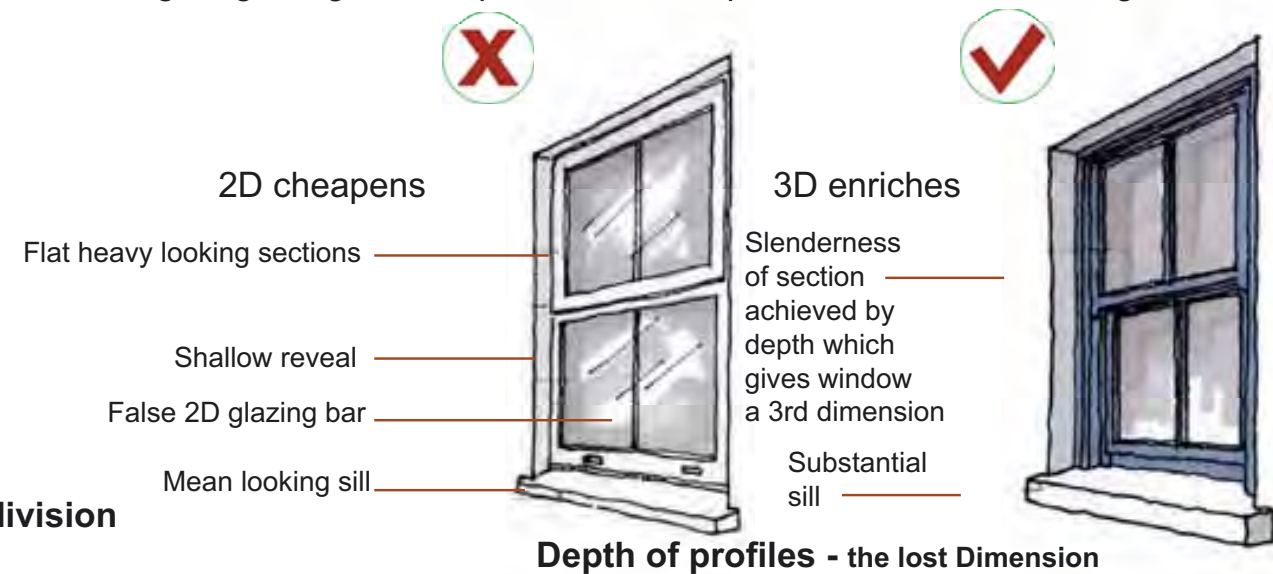

2D cheapens

3D enriches

Flat heavy looking sections

Slenderness of section achieved by depth which gives window a 3rd dimension

Shallow reveal

False 2D glazing bar

Mean looking sill

Substantial sill

Depth of profiles - the lost Dimension

dormers and rooflights

Changes in building construction techniques along with the extensive use of the double deep plan have helped to give rise, over the past 20 years, to the dormer bungalow house. On previous pages we have highlighted some of the disadvantages of this house type. Those together with the fact that dormers are so often finished in white PVC cladding can make them bulky and prominent in terms of the overall appearance of the house. That is not to say that there is no place for the dormer house. As illustrated within Part 3, modifications can be made to reduce the bulk of houses accommodating ancillary wings or eaves dormers. However, in many instances, depending on the site context and potential layout, a full two storey building may be preferable to a proliferation of dormers and rooflights. In general, dormers should only be incorporated in rural house design with restraint and care, following a few basic principles as set out below:

- 'Busy' eaves lines or roof planes should be minimised;
- The unseen slopes of roofs allow more scope for the inclusion of multiple or larger dormers, where absolutely necessary;
- In most instances rooflights are preferable to mid-roof dormers, especially on the visible public slopes of roofs;
- If dormers are used, simple wall-plate dormers (traditional eaves dormers) are the preferred form. Again care is required to how they are constructed and detailed;
- Avoid the use of white PVC side cladding, box fascias and soffits to dormers - stained timber or slate offer far more attractive alternatives;
- The location and frequency of rainwater downpipes (RWPs) needs to be considered from the outset with eaves and dormers. A proliferation of rainwater downpipes, especially white, on the front of houses should be avoided;
- Flashings, which allow rooflights to sit flush with a slate roof finish, are widely available and their more extensive use is actively encouraged by Cork County Council.



Presentation to the road and dormer location



Simple tidy presentation to public roadside

Avoid white P.V.C. box fascia & cladding

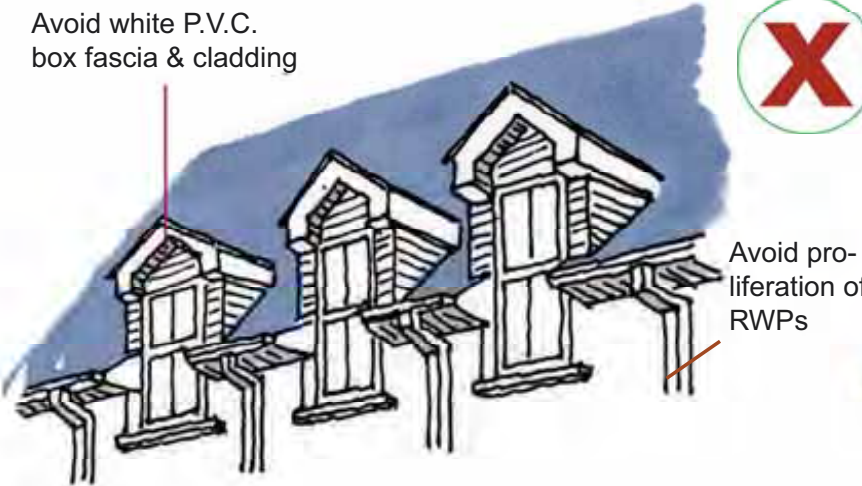

Avoid proliferation of RWP's

rooflight incorporated in lieu of 3rd dormer



Avoid ugly construction details and materials



Random rooflights proud of roof plane



RWP's not shown



Unightly RWP's



Equal roof lights flush with roof



House too small for so many RWP's



Better proportioning -wider house

Simple well mannered construction



Keep roof plane simple



Unattractive dormer type



Prominent non-traditional types

Unseen private side - dormers & large glazing possible



White P.V.C to be avoided



Avoid prominent mid-roof dormers

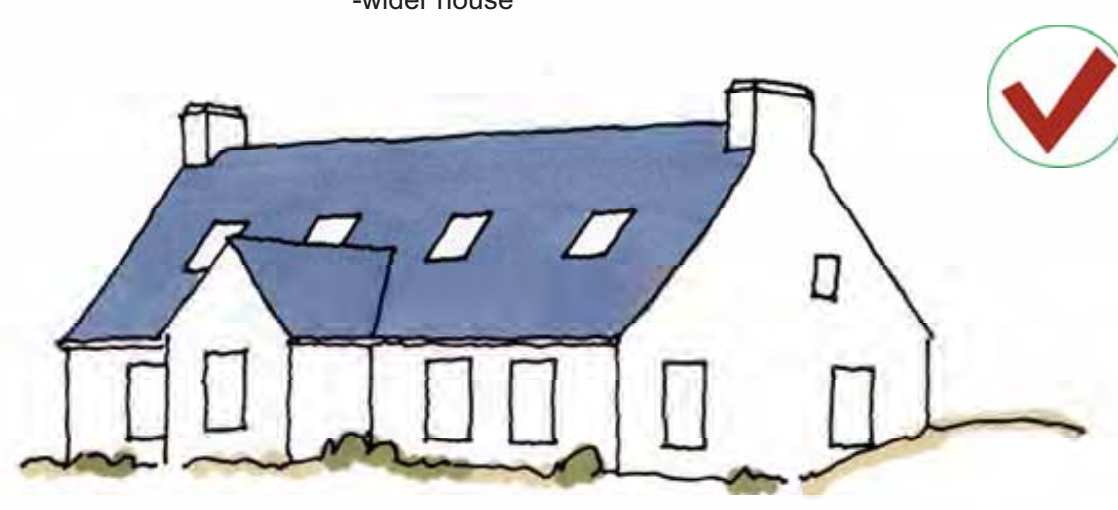

Preferred rooflight option keeps roof plane simple

doors

Traditionally much care was taken with this element of the house. Frequently it was the only item of embellishment on the otherwise simple exterior of Irish country, town and city buildings. Proportion, colour and detail are fundamental to making external doors an attractive feature of a house, as per the basic principles below:

- Doors should always reflect the shape of the opening and are most successful in their simplest form - in sheeted or panelled timber;
- Front doors should be viewed as an opportunity to introduce interest, contrast and enrichment to a house;
- White PVC, aluminium or varnished tropical hardwood reproduction doors are actively discouraged and should be avoided. Sustainable painted or natural hardwood alternatives are becoming more readily available for external joinery and their use is actively encouraged by Cork County Council;
- With conservation or refurbishment work, skilled joiners can replicate the detailing and features of period doors accurately;
- Discretion in the selection and use of colour in Cork countryside houses has traditionally been used to great effect to enhance design. Strong contrast in colours between, say, a boldly painted front door and plainer surrounding walls can bring significant visual interest and style. New exterior wood coating products are available for finishing timbers which are a good substitute for high gloss paints, offering a more `maintenance friendly' finish;
- Whilst the door and surround often needs to admit light to the hallway, large glazed panels in doors can look over-elaborate. A window above or beside the door, as in the traditional examples, is a good compromise, which leaves the simple door intact. Fanlights over doors can also be used to increase light to hallways;
- Carefully consider electrical lighting to the front door. Avoid bulkhead type light fittings and explore other light fittings and options for location;
- Avoid unsightly, prominent location of ESB meter boxes. These can easily be discreetly located (refer to illustrations on facing page).





Simple Attractive Front Door



solid with small light partial glazed vertical panelled partial glazed contemporary partial glazed and panelled solid panelled

Preferred Doors

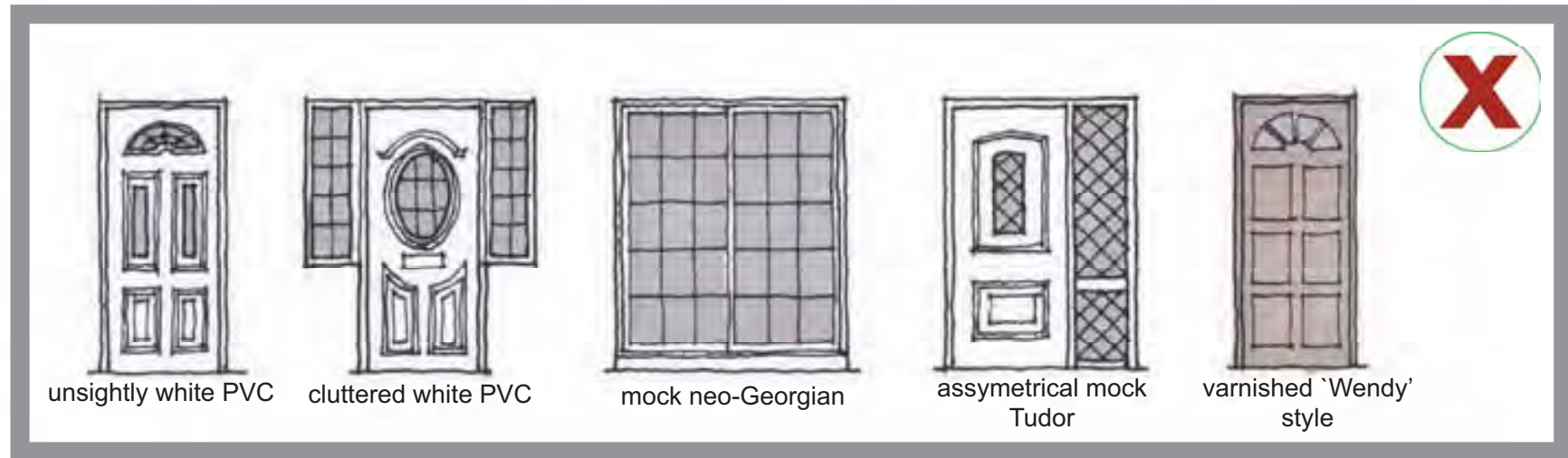

unsightly white PVC cluttered white PVC mock neo-Georgian asymmetrical mock Tudor varnished 'Wendy' style

Types to Avoid

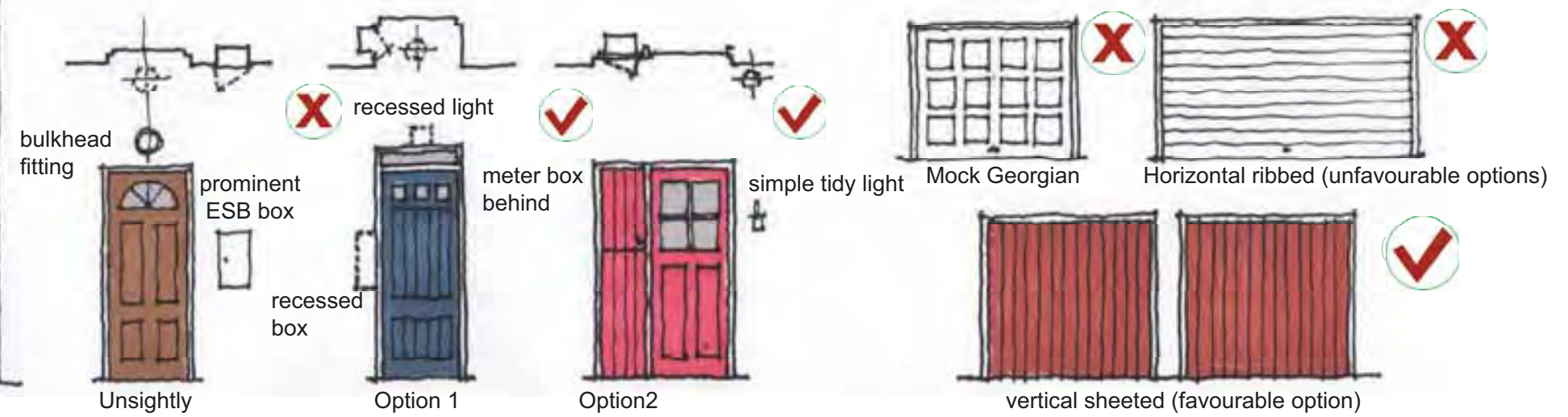

bulkhead fitting



recessed light



simple tidy light



Mock Georgian



Horizontal ribbed (unfavourable options)



vertical sheeted (favourable option)

Unightly

Option 1

Option2

Doors - ESB Boxes & Lighting

Garage Doors

porches and canopies

A key characteristic of Cork rural houses is that there is little or no modelling of the front plane of the building. Porches expressed on the outside of houses, or add-on canopies were much rarer than today. Occasionally small porches or canopies were found over older cottage doors, particularly on single storey houses. These add interest to the building, however it was rare to find porches on 2-storey houses as the cost combined with the very low sill level of the first floor windows of the typical 3-bay rural farmhouse made their inclusion very difficult. Today, the need to compensate for the difficult proportioning arising from regulation heights, together with the increased size of our homes gives rise to virtually every new house having an expressed porch or canopy to the front of the house, which is generating very busy lines in our countryside.

Furthermore, good sustainable energy efficient design practice demands the inclusion of buffer zones in our houses between the inside and outside to reduce heat losses as people enter and leave. Many older houses have such buffer zones internalised within the house, leaving the outside unadorned; a practice we should emulate today.

In summary we need to ask the question do porches need to be placed at the front of the house? Cork County Council would encourage the placement of porches to the side, rear, or better still internalised within the volume of the house.

Where porches are incorporated, the following points should be considered:

- Porches should be carefully detailed and built with good quality materials - avoid white plastic where possible;
- The size and shape of the porch should be well proportioned. Small roofs do not need rainwater goods;
- Introducing a different material for this element only, such as brick or stone, should not be necessary on simple houses;
- The use of 'mock' or 'false' classical type porches are best avoided.



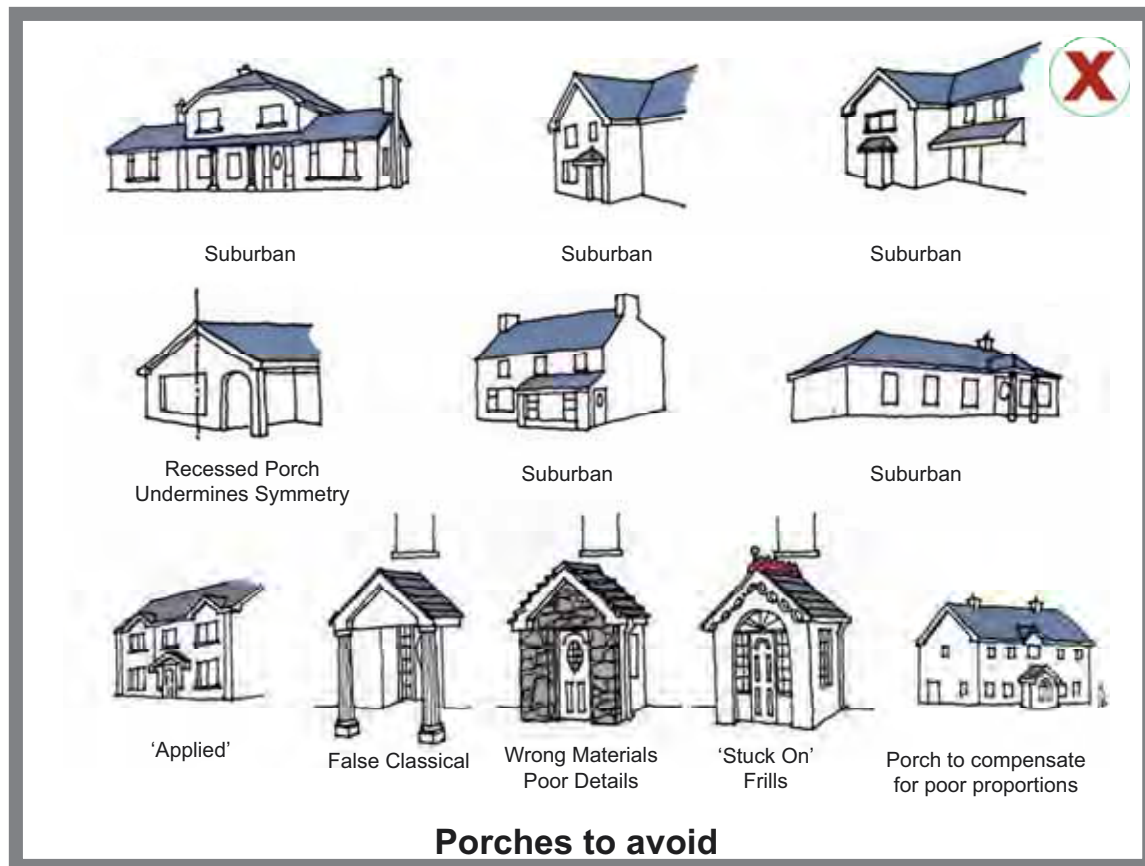

Porches to avoid



Simple Canopy



Traditional Canopy



Simple shelter to front door



Simple porch form + detail



Simple Surround

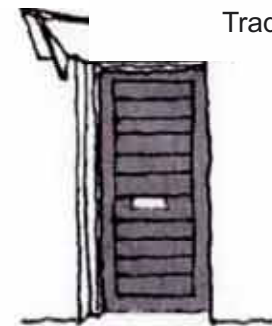

Contemporary Type

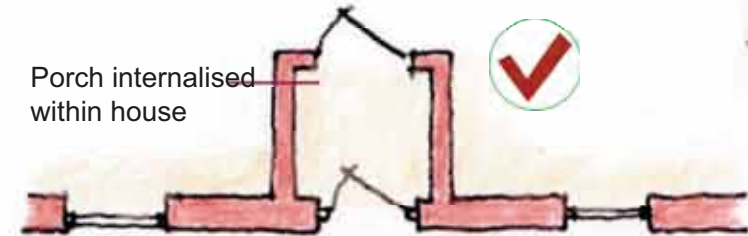

Porch internalised within house

Preferred option



Contemporary alternative

conservatories/sunspaces

Conservatories or sunspaces can be very attractive features of new houses or, more commonly, subsequent additions to older houses. They can act as very useful visual 'release-points' in more solid houses. Many new eco-houses are designed with the sunspace as the central organising element (in terms of orientation, plan arrangement and section) to maximise passive solar heating gains and bring down energy costs to a fraction of that of normal houses. These eco-houses require very careful siting. Reconciling technical and aesthetic requirements can be quite difficult and demands great skill.

The shape of the sunspace should be consistent with the house to which it is attached.

- The size and location of an ancillary type sunspace requires careful consideration with respect to proportion, size and the spatial layout of the house
Sunspaces immediately beside kitchens will be most extensively used;
- Avoid conservatories/sunspaces, which are 'out of scale' with the rest of the house;
- The construction materials of the sunspace are fundamental to its successful appearance. 'Flat' white PVC profiles are generally the least successful due to their bulky sections and garishness of their particular white colour. Many firms offer low maintenance roofing framework in attractively profiled sections, along with timber framework to the sidewalls;
- Revised building regulations seek to minimise heat losses from these elements of houses. This impacts on the design of all new sunspaces in terms of extent of glazing and framework, with doors to seal off from the rest of the house. This aspect of sunspace design will require much more careful consideration in the future;
- First floor conservatories are particularly difficult, both in terms of their visual appearance/obtrusiveness and possible privacy issues. Generally they should be avoided. If they are used, a much more skilled approach is required;
- It is preferable that glare and over-heating concerns are dealt with either by reducing the extent of glazing, or the use of blinds, rather than using heavily tinted glass;
- Ventilation is fundamental to successful sunspace design in terms of comfort. The location and disposition of opening windows/vents impacts significantly on the overall appearance and needs to be considered from the outset.



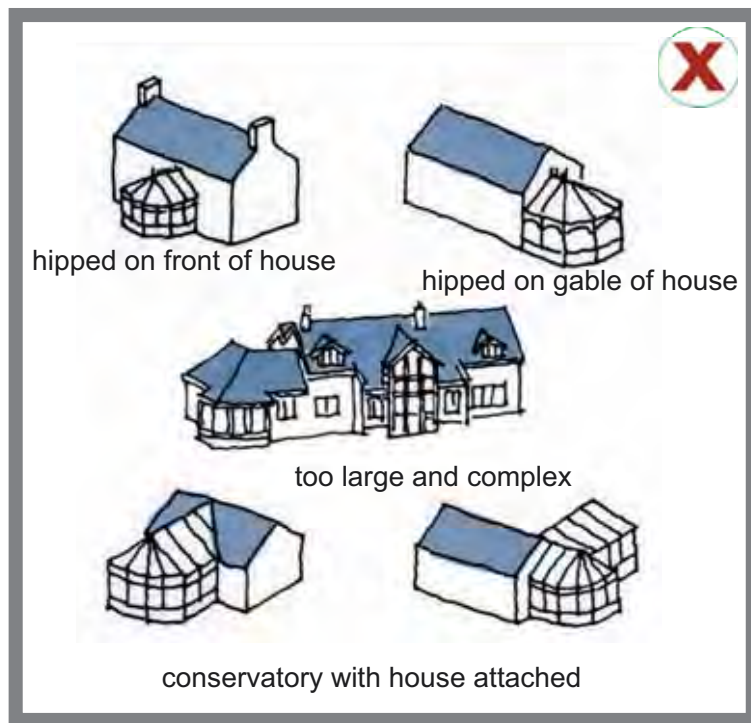

Types to avoid

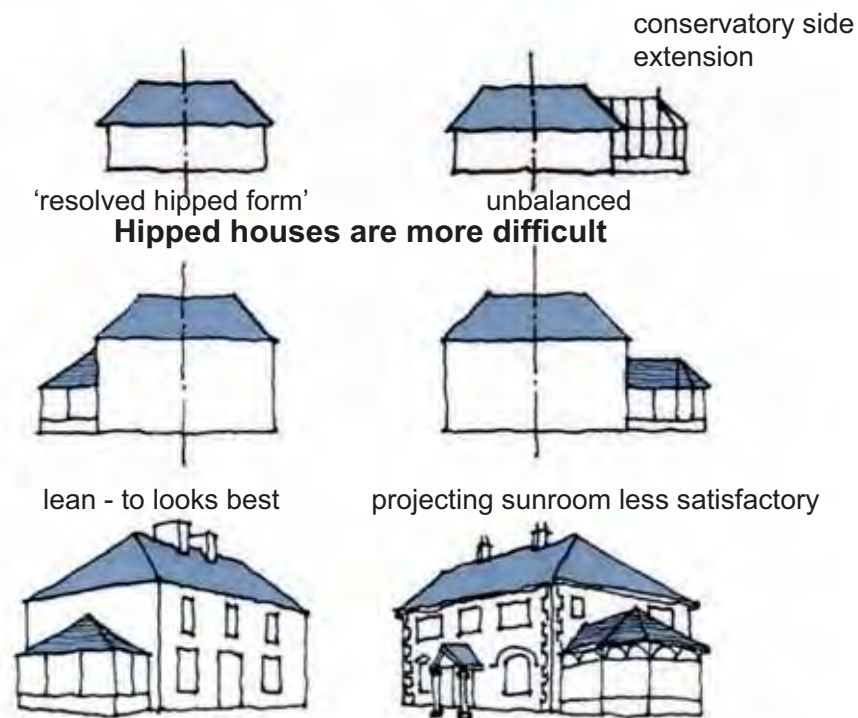

Rural Solution

Suburban Approach

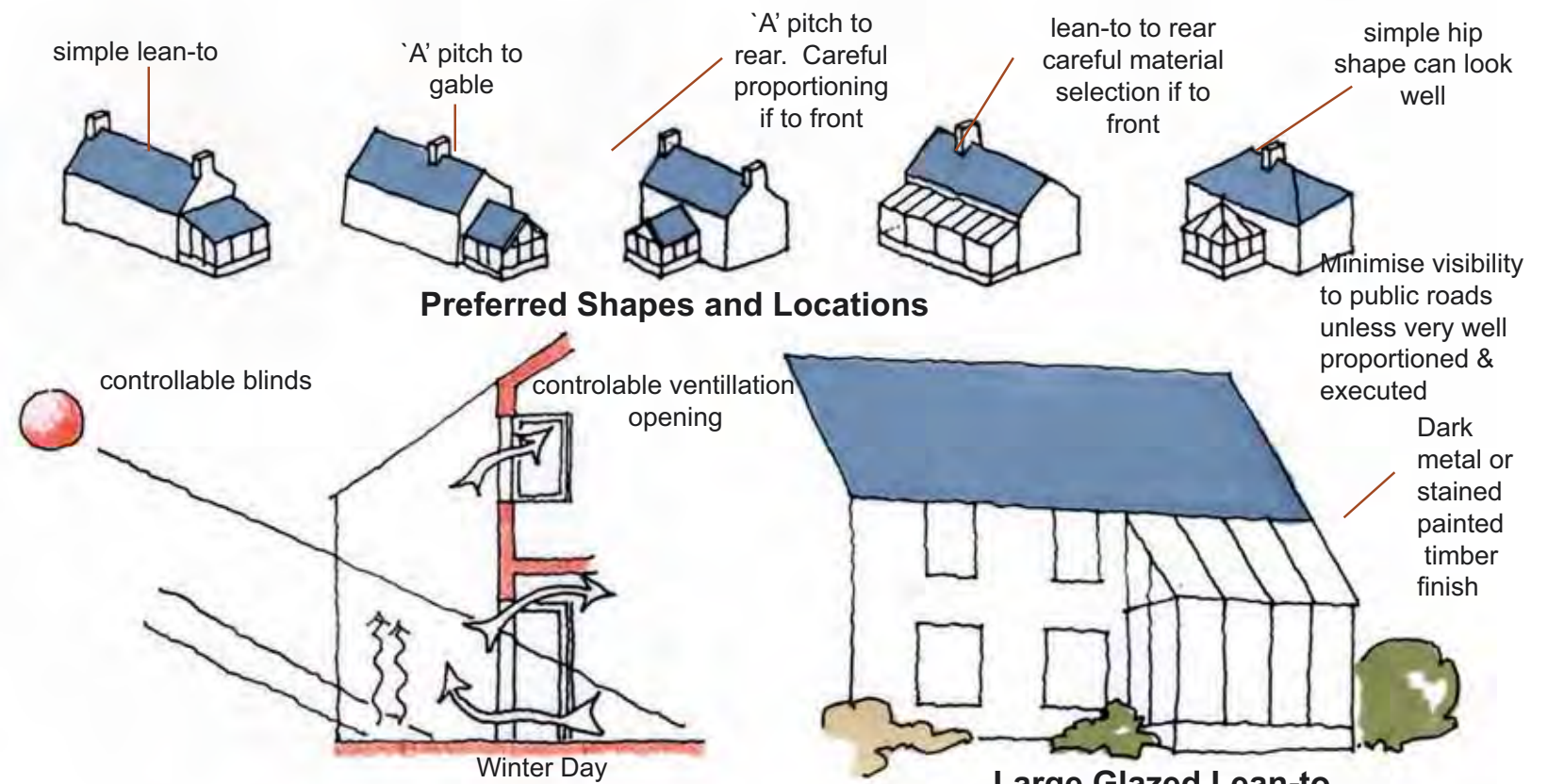

Preferred Shapes and Locations

Maximise on passive solar gains

Large Glazed Lean-to



Numerous alternatives possible

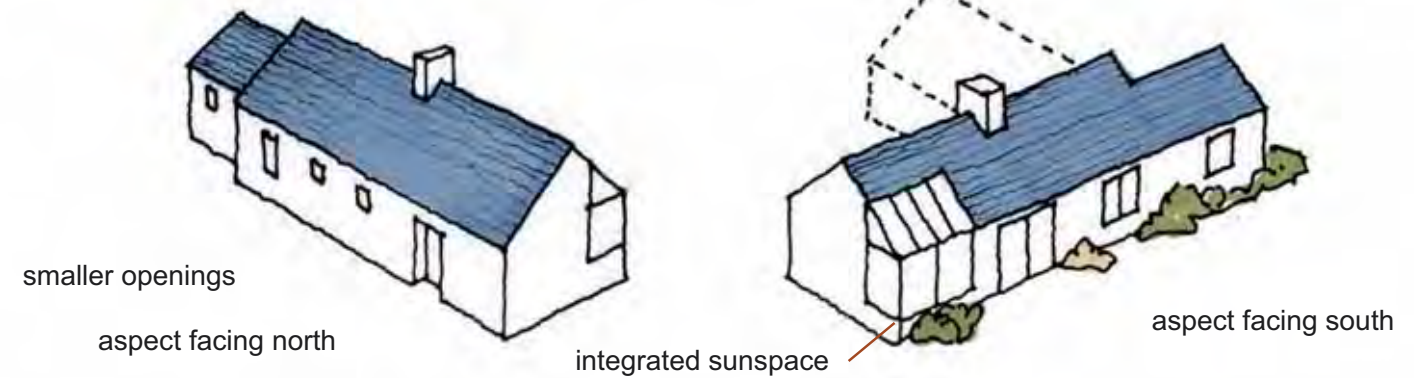

Small house - sunroom & conservatory studies

external finishes ... regional characteristics

Not only does the particular shape of a building give a region its identity, but also the finishes applied, or as importantly not applied, to the outside of a building show distinct regional variations. For example, as one travels across Cork, the coastal fishing villages of the west are very distinctive with their brightly coloured painted houses. Kinsale, on the other hand, is particularly noted for its slate hanging to external walls. This was a practical measure arising as a means to prevent the continuous driving rain penetrating internally. Interestingly this is also a feature of coastal villages of the southwest of England with which Kinsale historically has strong links. Further east and north, thatch as a roofing material is far more commonplace.

East Cork is notably high in limestone, which gives a very different appearance to the stone walls of the countryside in the east, being built of stones that are roundish and light grey in colour. Perhaps for this and associated reasons, colours, as one heads north and east across the county, become more muted - typically limewash greys, off whites and soft yellow ochres. Brickworks were located around Youghal and elsewhere in the east of the county, where clay, suitable for making brick, was found and consequently brick houses are more common. Elsewhere in Cork brick was often used for practical reasons to construct parts of the walls, forming corners and arches, such as around door and window openings, external corners and chimney stacks. More often these elements were then plastered over to give the building a uniform appearance and resist water penetration. The recent trend of hacking off the render finish to the outside of buildings has exposed these brick elements. This is regrettable as many building interiors are now at risk from water penetration, while also the uniformity and clarity of our vernacular is becoming confused. New houses are being built to replicate the stripped houses, which were never meant to be seen, producing houses with stone cladding or non-functional brick applied around corners, to chimneys and so on. Similarly brick and stone or concrete should not be mixed randomly 'for effect' or as 'features'.

Upgrading of the traditional style to suit our modern lifestyle can lead to proliferation of pipe work and cabling associated with modern appliances, which can disrupt architectural features or elevations. Locate pipework internally wherever possible and consider painting pipes to blend with the roofs or walls of principal elevations so as to minimise their visual impact.



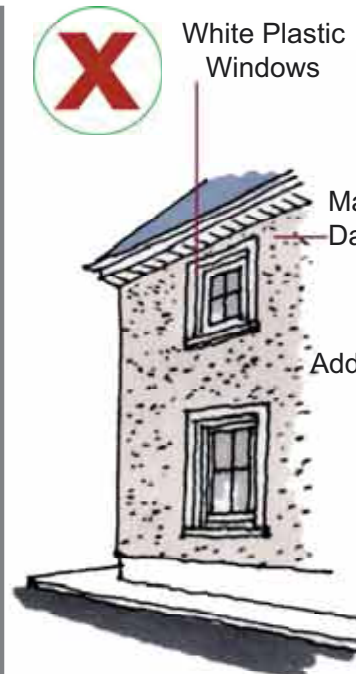
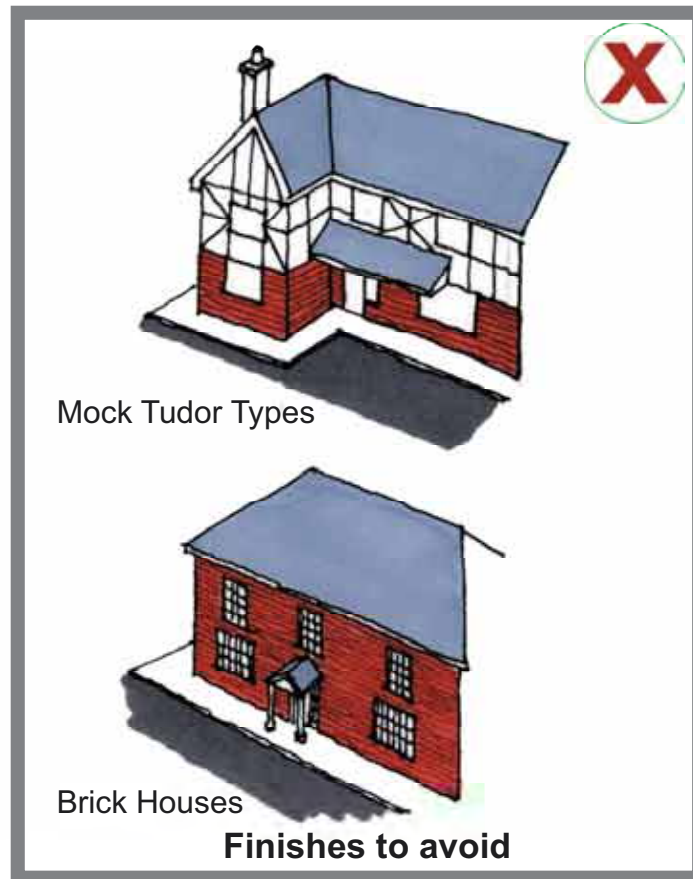

The "maintenance free"?

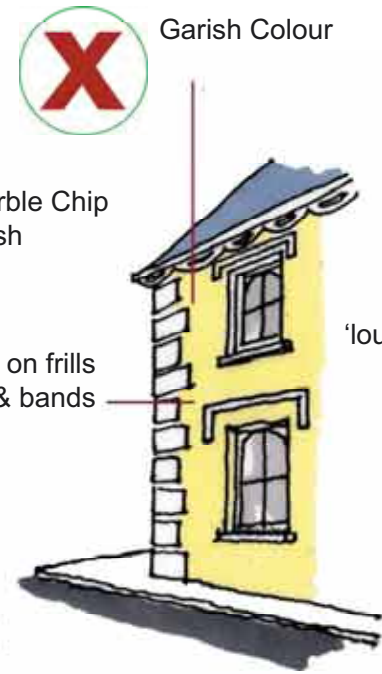

The over dressed

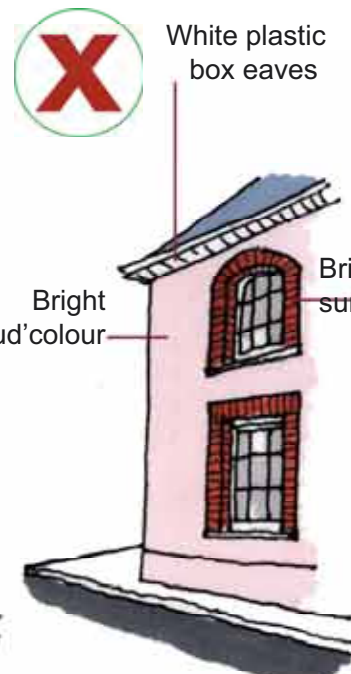

The Suburban

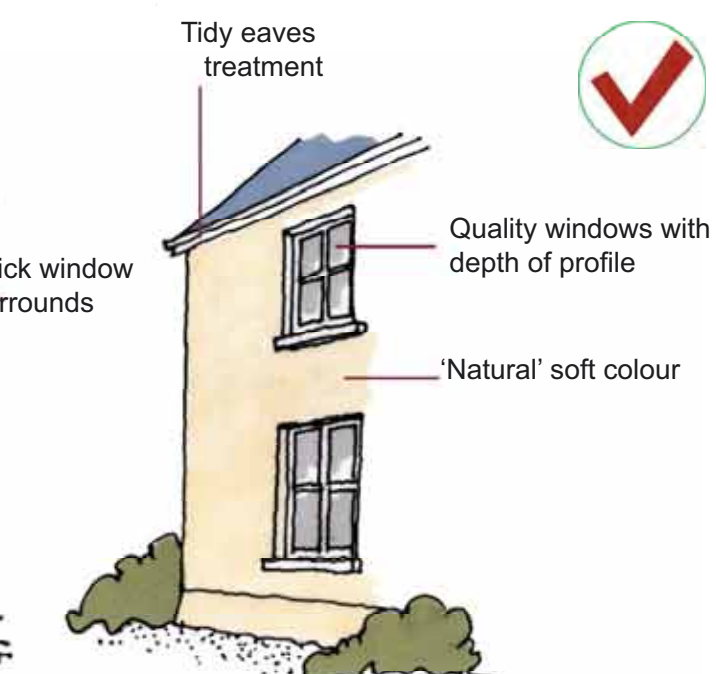

Cork rural house

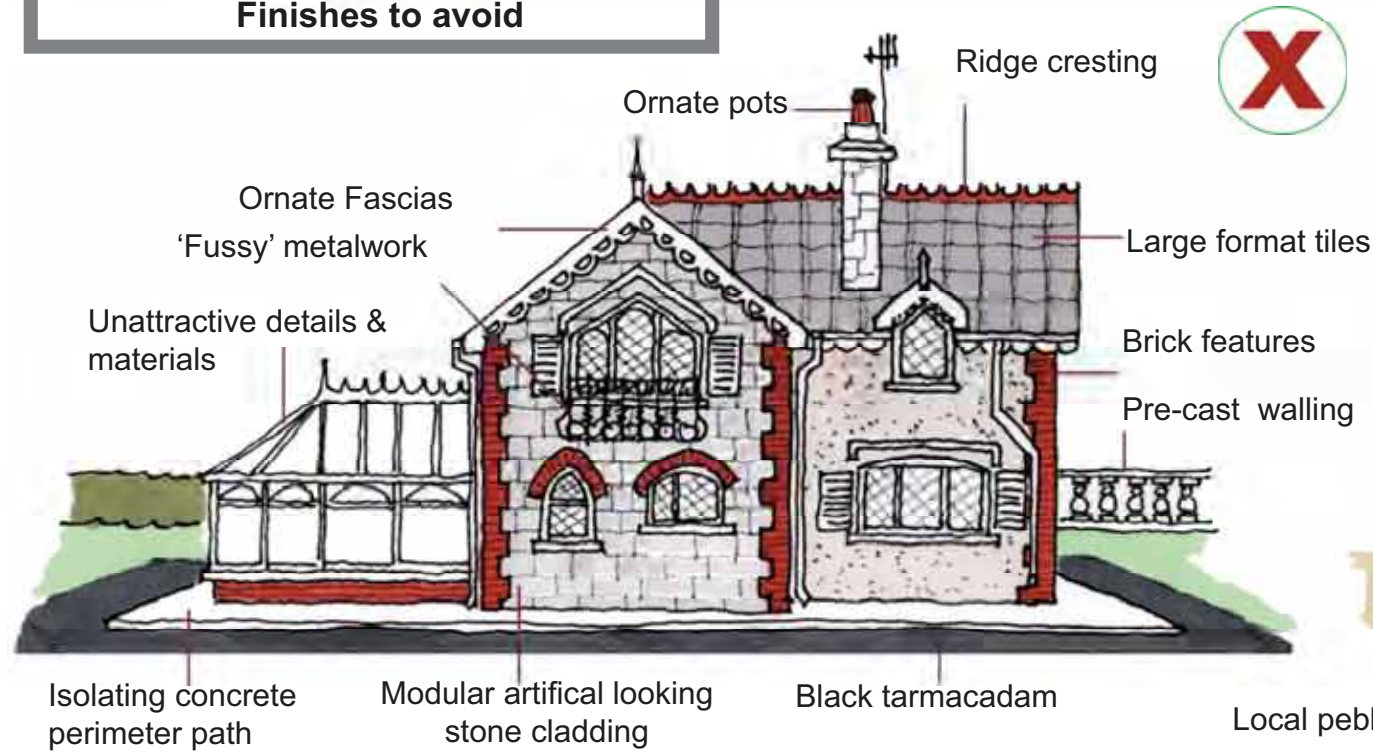

Expensive add-ons & frills used to compensate for poor design

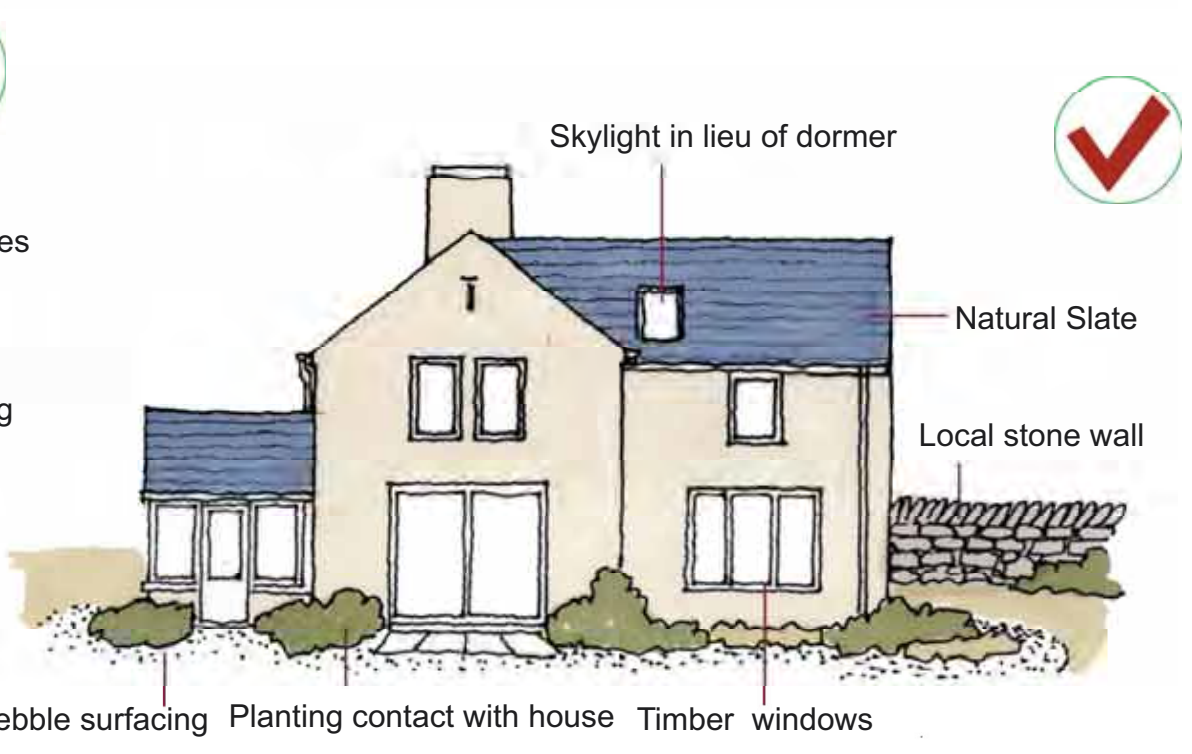

Contemporary rural house continues tradition of simplicity

stone

It is important to be aware that while traditional Cork rural houses were, more often than not, built with stone or clay walls, they almost always had painted plaster finish – a characteristic which should be retained and continued by and large. The render finish applied to the walls was necessary to act as an `overcoat' to the houses, keeping the water out, given the severe driving rain across the County. Rough cast renders were the traditional external coatings applied to rubble-walled buildings. Materials such as marble chip finish and some pebble dashes, which are intended to be maintenance free, not only frequently appear at odds with the locality but also deteriorate and grow unsightly over time, and should generally be avoided. Stone finished buildings do exist, but these tended to be either `grand' cut stone structures such as churches, banks, and courthouses, or utilitarian structures such as outbuildings, barns, mills and so on. This created an attractive clarity in the hierarchy of rural buildings types while at the same time forming a uniformity to the appearance of our houses in the region.

Notwithstanding the above, stone used with consideration and skill can be very attractive, and such use is to be encouraged as follows:

- Stone cladding to ancillary `wings' or other elements such as garden or boundary walls can provide attractive contrast and help reduce the apparent size of buildings;
- Certain landscapes or sensitive locations can benefit substantially where stone is used extensively on the outside of a house to marry it harmoniously with the site;
- Stone can also be used very successfully in more skilful contemporary houses, providing an interesting play of heavy and light materials;
- An important but general rule where stone is to be employed is that, where possible, it should be of the locality so that there is a consistency in colour that links successfully with other stone structures, ditches, rock outcrops, etc. in the immediate vicinity. For example, a light grey limestone boundary wall typical to East Cork would look very incongruous among the blue slate/shale of Baltimore and vice versa;
- Avoid 2-dimensional type effects with stone, which give it a very false `applied' appearance. Traditional Cork rural buildings have an honesty and simplicity values which are worth retaining and emulating in new rural buildings.



stone finishes

Inappropriate use of stone

- 2-D Facing panels
- Arbitrary veneer effects
- 2-D Gable treatments "add-ons"
- Feature
- 'Odd' use of stone
- Stone "bits" for effect
- Pipes disappearing into stone
- Piers in stone wall

Cork rural houses are traditionally plastered finish sometimes with ancillary stone 'wings'



3-D stone elements

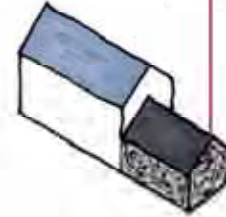

Stone used is native to the locality

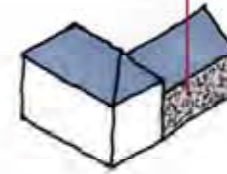

Stone used to give emphasis to main structure



Preferred use of stone



Stone used to provide contrast and reduce apparent size



Stone walls for shelter links buildings with the land on Cape Clear

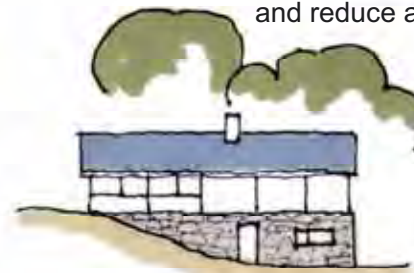

Stone plinth links house with site



Stone walls provide effective shelter & contrast



Building with the landscape



Building as part of the landscape



Building as part of the landscape

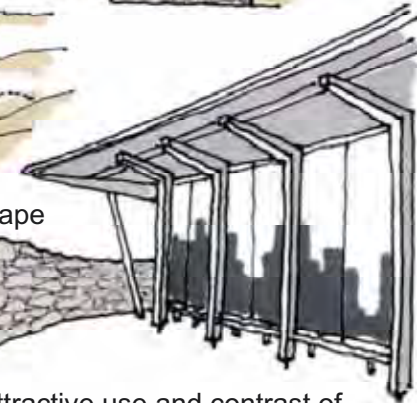

Attractive use and contrast of 'solid' & 'light' natural materials

Attractive use of stone



colour

The choice of colour and materials makes all the difference to the impact of a house on the rural landscape. The most important principle is to use colours which blend in with local traditions and surrounding buildings. In general, the use of earth colours on buildings in the countryside will best complement the natural environment through the seasons and reduce impact, particularly given the larger size of today's homes.

Historically, whitewash was the decorative material used in domestic architecture. A light grey or ochre colour was also used. In some parts of the county, notably West Cork, the enthusiastic use of colour was one of the dominant features of local architecture. In North Cork the use of colour is much more restrained, with a more prevalent use of off whites and greys.

Simple guidance for colour selection is to prepare a colour chart of the main hues of vegetation to appear on a site and its immediate surroundings, including the seasonal variations throughout the year, and use this as an aid to the most appropriate choices.

A key characteristic of rural vernacular building is that the use of strong contrast between the differing finishes of roofs, walls, and doors is frequently the sole means of introducing visual interest or giving a 'lift' to such buildings. It is this discretion in the use of colour that greatly enhances such simple design. As a general principle, light colours should be used on walls complemented by strong colour, particularly on the door. Roofs tend to reflect more light than the walls, therefore dark colours are more desirable. Dark colours on roofs, such as the blue/grey of natural slate, reduce the apparent size of buildings, whereas light or reflective materials increase apparent size, drawing attention to them. The colour should match that of neighbouring buildings. Painted corrugated tin roofs complement white walls. The use of strong colours, the reds, greens and browns of the iron roofs of rural buildings create a distinctive image for rural architecture.





summary & checklist constuction details

have you:

Considered the roof profile, i.e. height and pitch of the roof, to blend in with the local environment?

Used roofing materials that respect and reflect the tradition of their location and surroundings?

Detailed roof edges that are appropriate to their context?

Carefully located the chimney positions and ensured there is substance to their appearance?

Arranged the openings, i.e. doors and windows, to provide good natural light and views whilst maintaining an attractive composition overall?

Used good quality windows and doors that are attractive in terms of size, design and materials, and are responsive to local traditions?

Used windows and doors that comply with fire safety regulations; energy conservation regulations; and disabled access regulations?

Where dormers or rooflights are used, ensured that they are carefully detailed to minimise visual impact?

Where a porch is to be included, questioned whether it must be expressed or can it be internalised?

Where a sunspace is incorporated, designed it so that it respects the proportions and materials of the house and is it energy efficient?

Used materials and finishes in a way that is consistent with the local character, enriching the house's appearance?

Used colour effectively to enhance the building whilst still appearing satisfactory within the landscape?



appendices

- **Worked Example: Sketches and Drawings'**
- **Addressing the Deep Plan House**
- **Trees and Shrubs**
- **Bibliography**

worked example

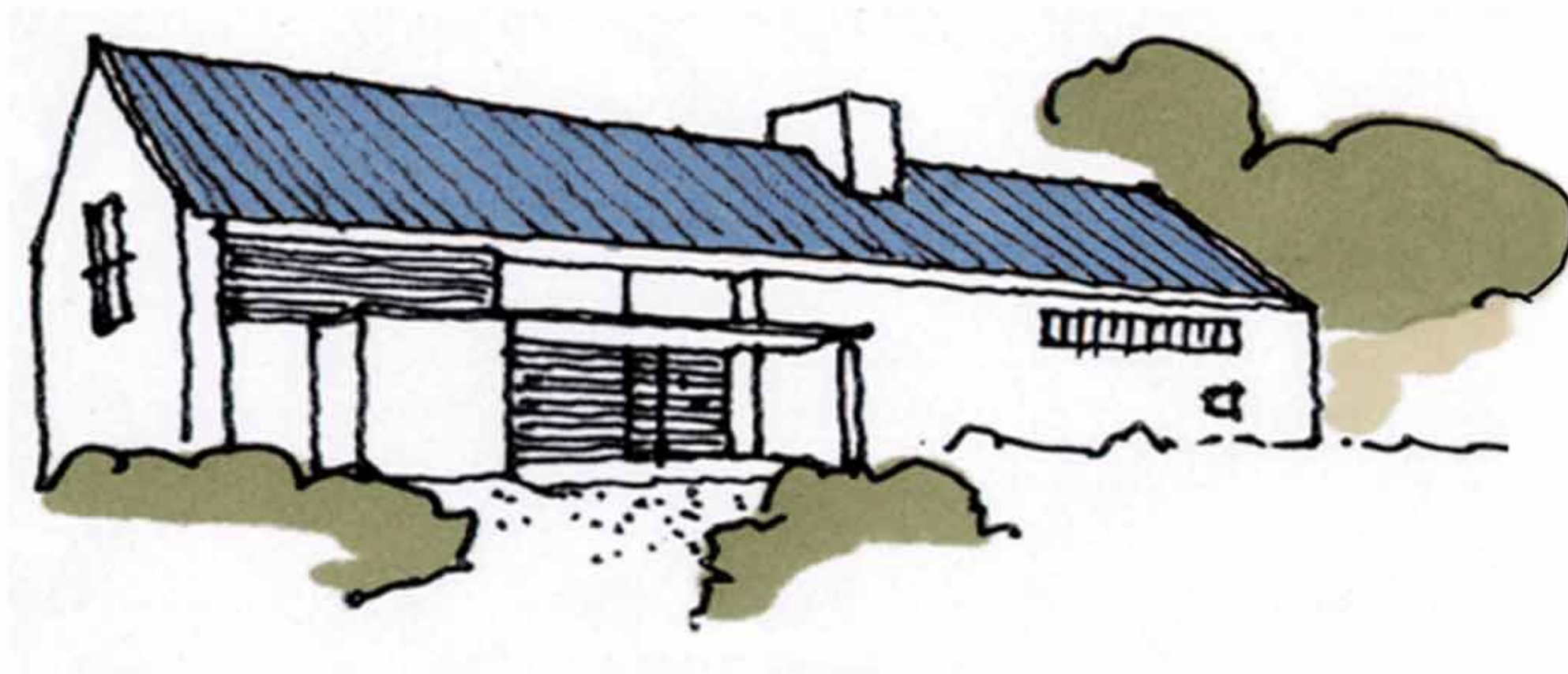

Low eaves, Simple form, Larger glazed area to south, Simple detailing, Slate roof, Strong chimney, Limited palette of quality materials



bringing it all together

Using the advice set out in the previous sections, this section shows how all the various considerations may be pieced together to produce the most favourable outcome for the site in question. This is a step-by-step example of all the details that should be included in a planning application to enable the planner to swiftly assess your application for a house in the Cork countryside.

For this worked example a north-facing site has been selected, and the layout and house design in this case is a very contemporary one, but draws upon elements of Cork tradition to ensure that the finished development blends well into the locality. An unusual design such as this may require specialist input to demonstrate compliance with building regulations but this would not affect the planning application itself.

It is worth noting that local OS Discovery series maps, which are readily available in most newsagents, can be very useful in assessing a site's prominence.



● site location



● prominence check



● site analysis



● view from road - east



● view from road - south



● view down laneway



● view southwest from site boundary

preplanning

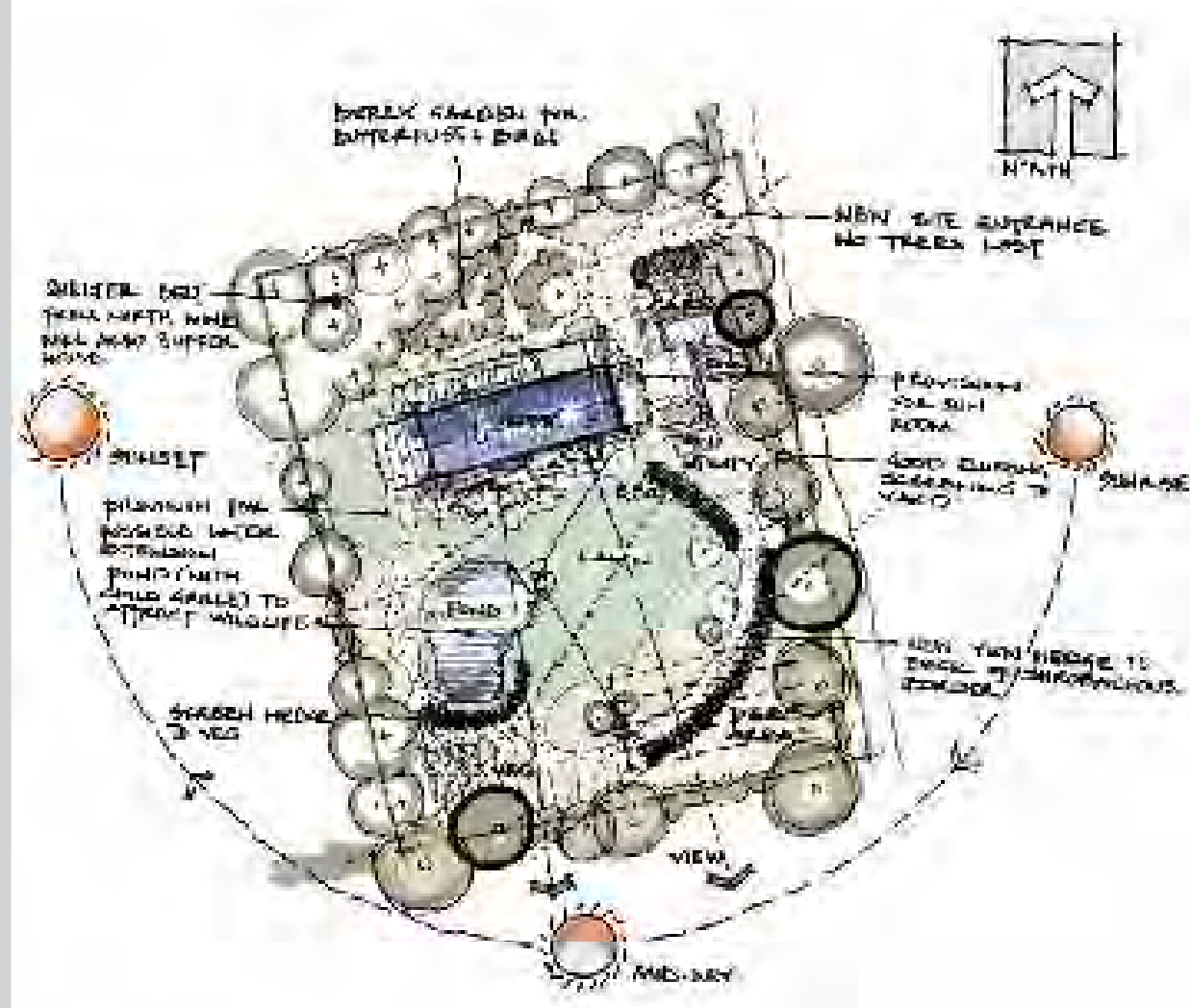

● site layout

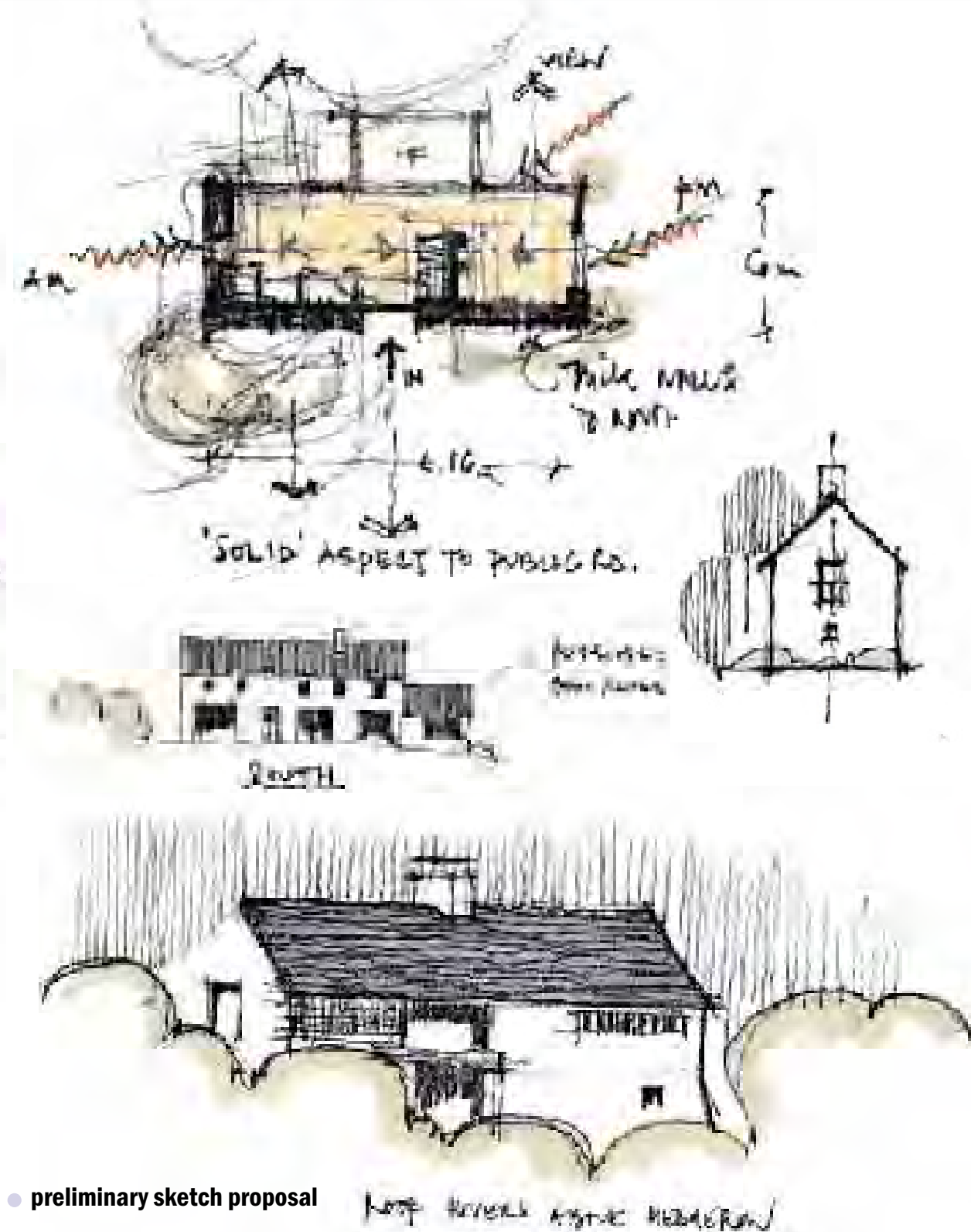

● preliminary sketch proposal

Sketch design of narrow plan house

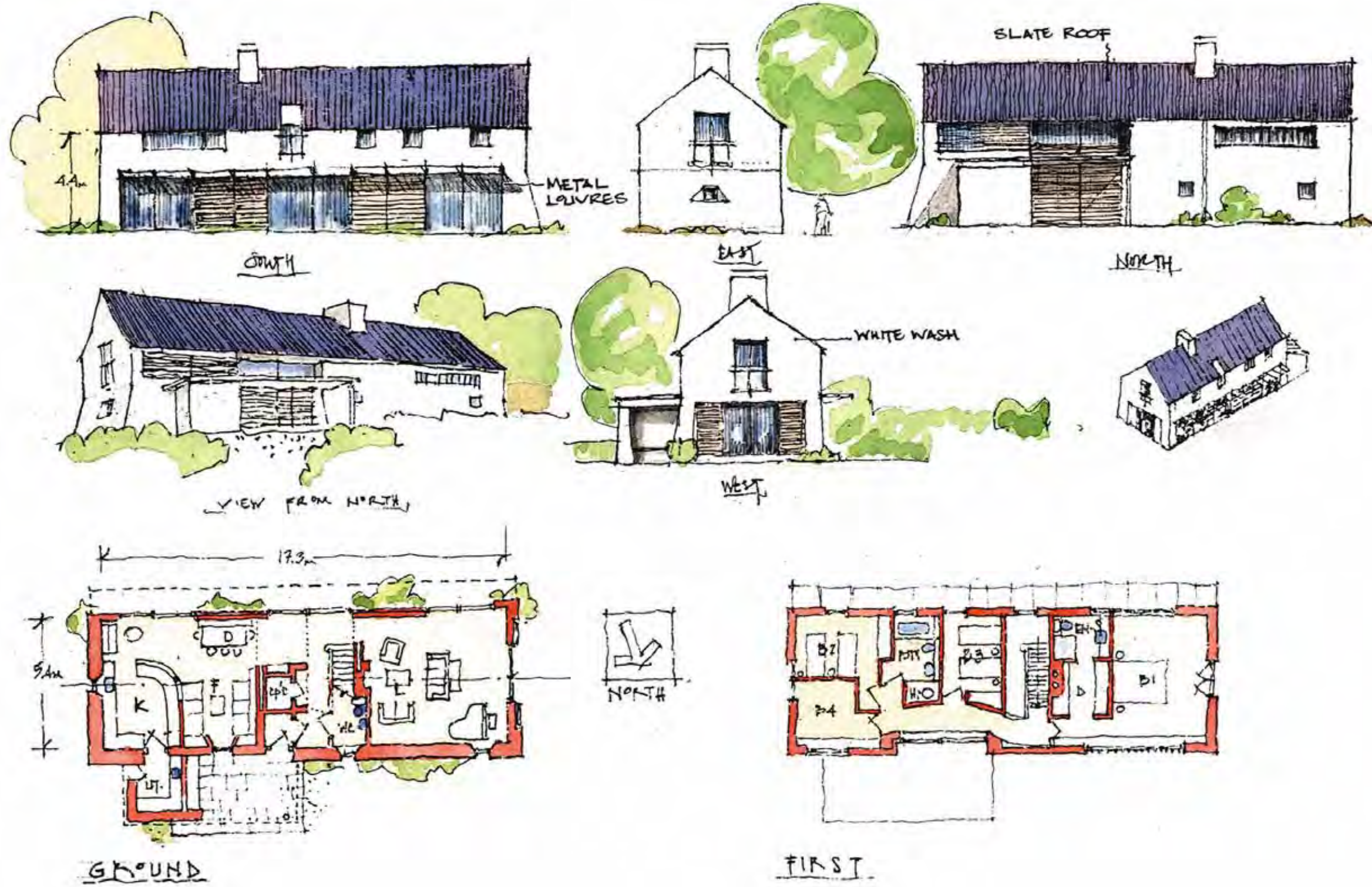

Site Location Map

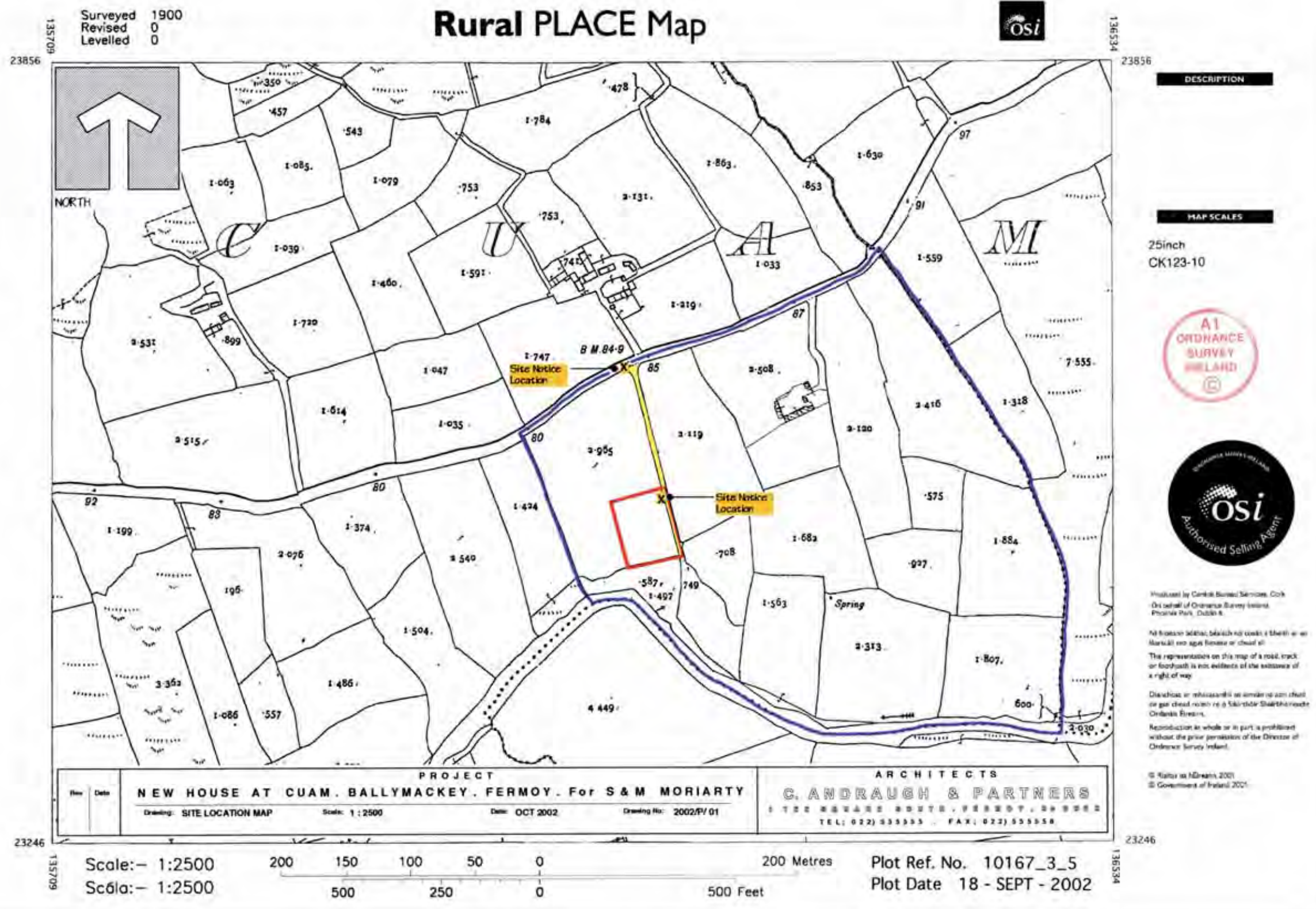

Planning Application Drawings

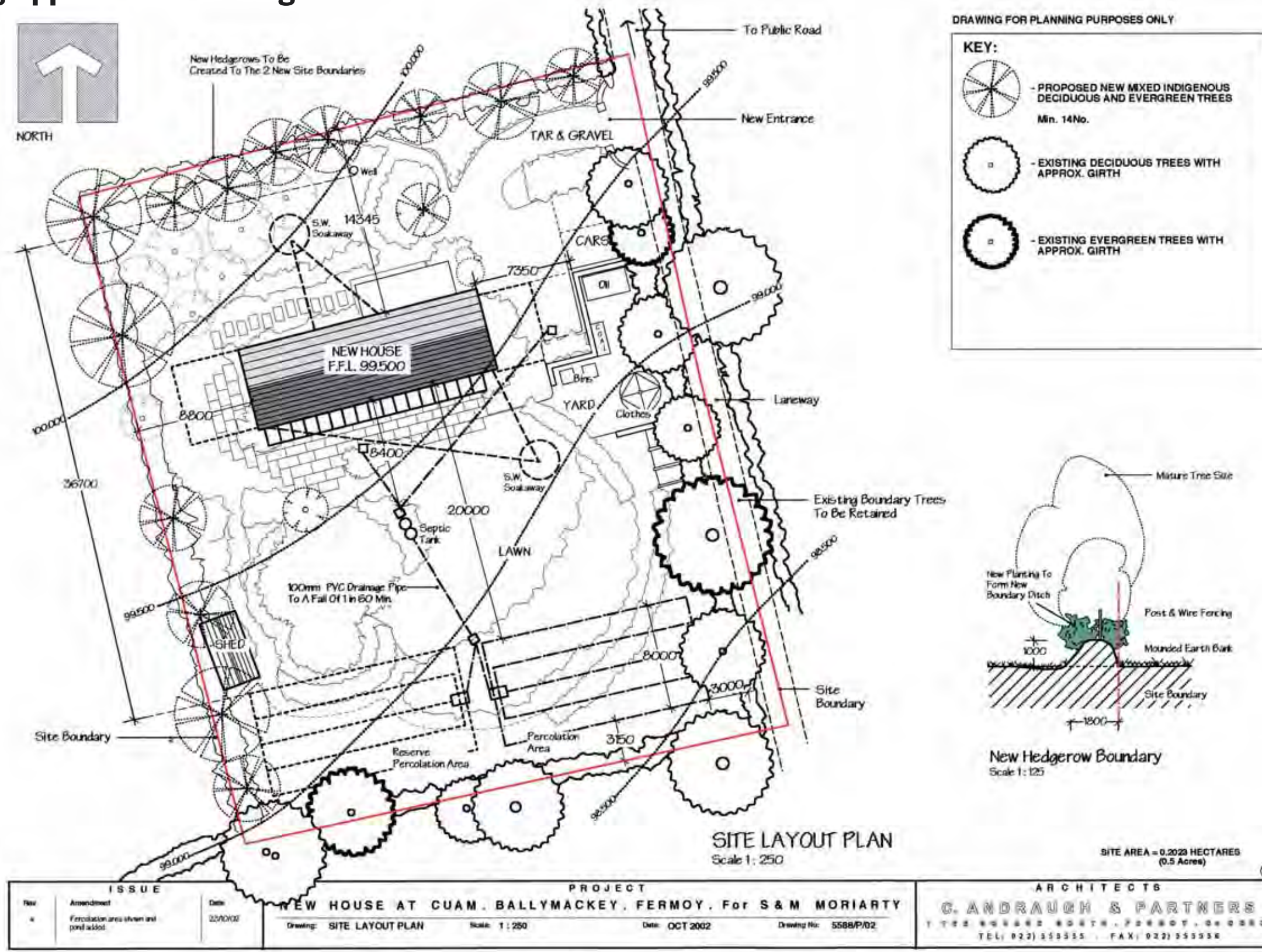

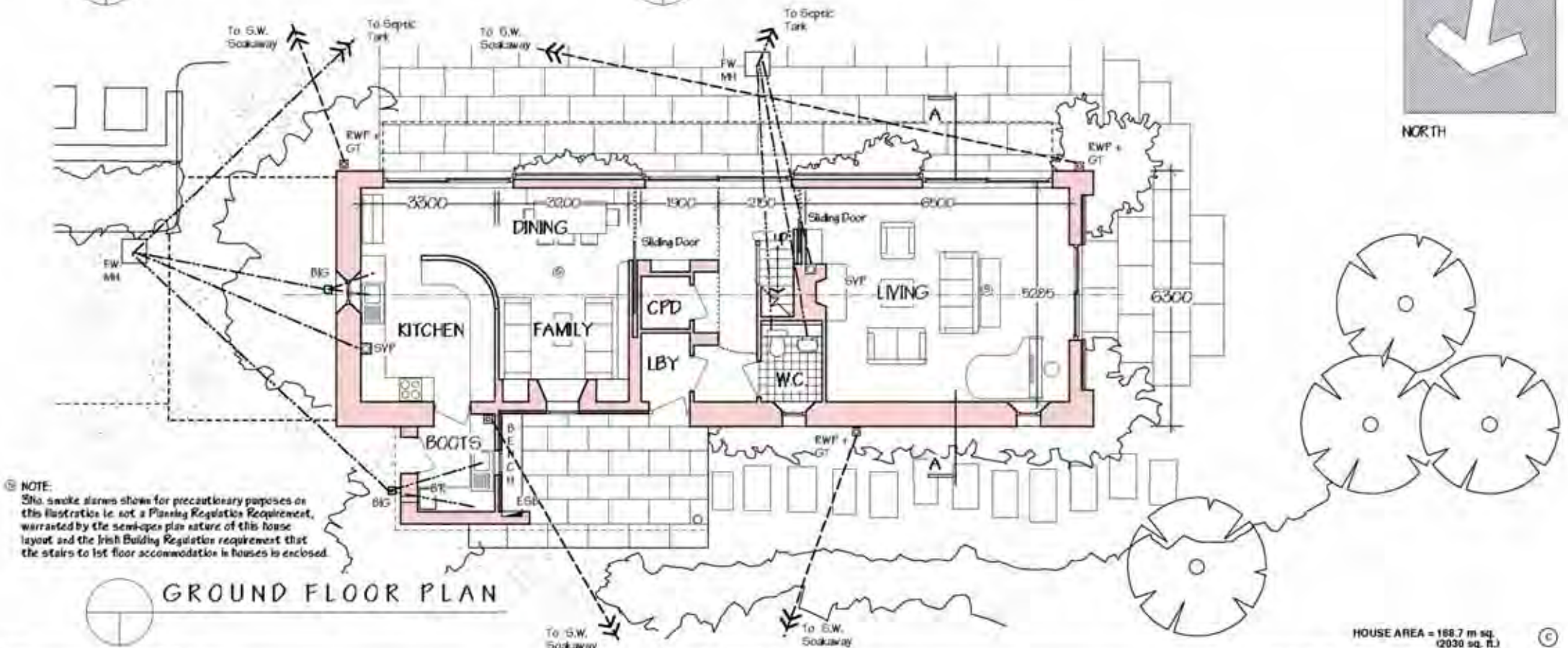

ISSUE			PROJECT			ARCHITECTS			
Rev	Amendment	Date	NEW HOUSE AT CUAM, BALLYMACKAY, FERMOY, For S & M MORIARTY			G. ANDRAUGH & PARTNERS			
			Drawing: GR FLOOR PLAN NORTH ELEVATION	Scale: 1:100	Date: OCT 2002	Drawing No: 2002/P/03	1 THE SQUARES BUILDING, FERMOY, CO. WEX		
						TEL: 0221 688685 - FAX: 0221 688688			

DRAWING FOR PLANNING PURPOSES ONLY

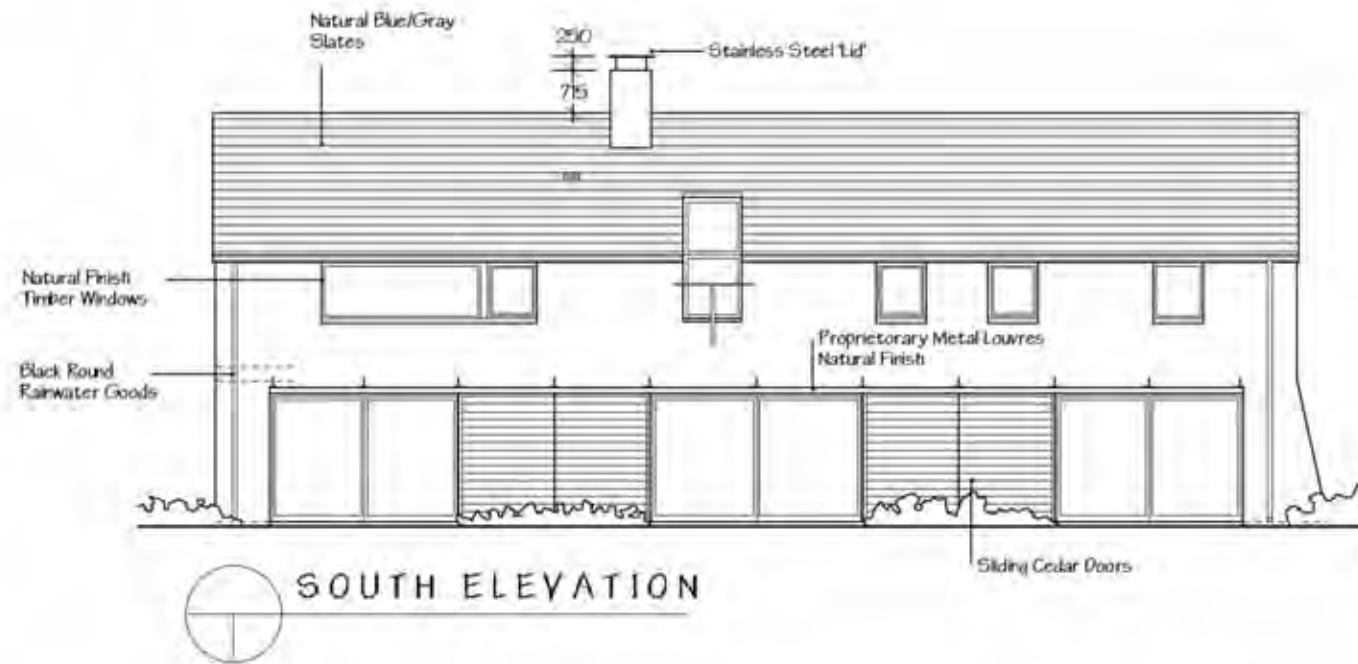

SOUTH ELEVATION

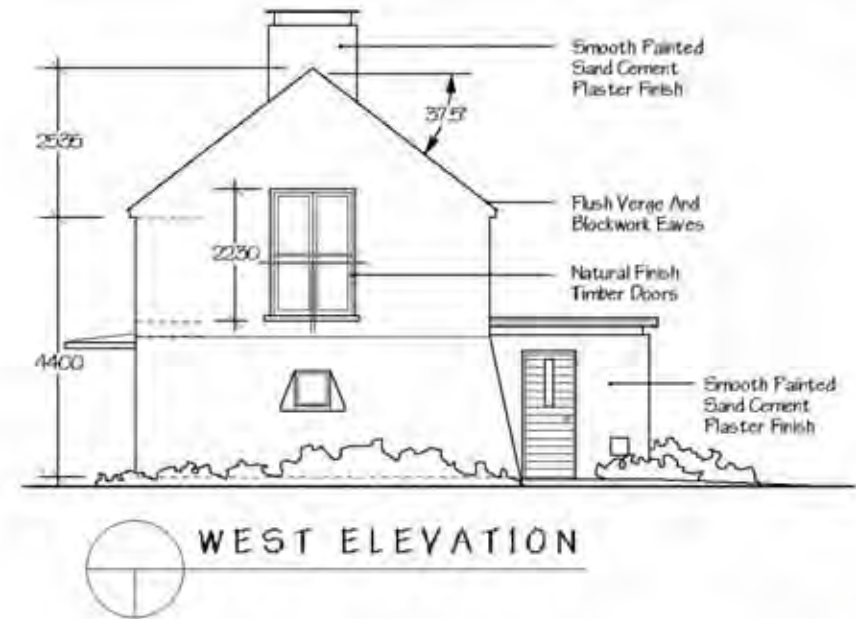

WEST ELEVATION

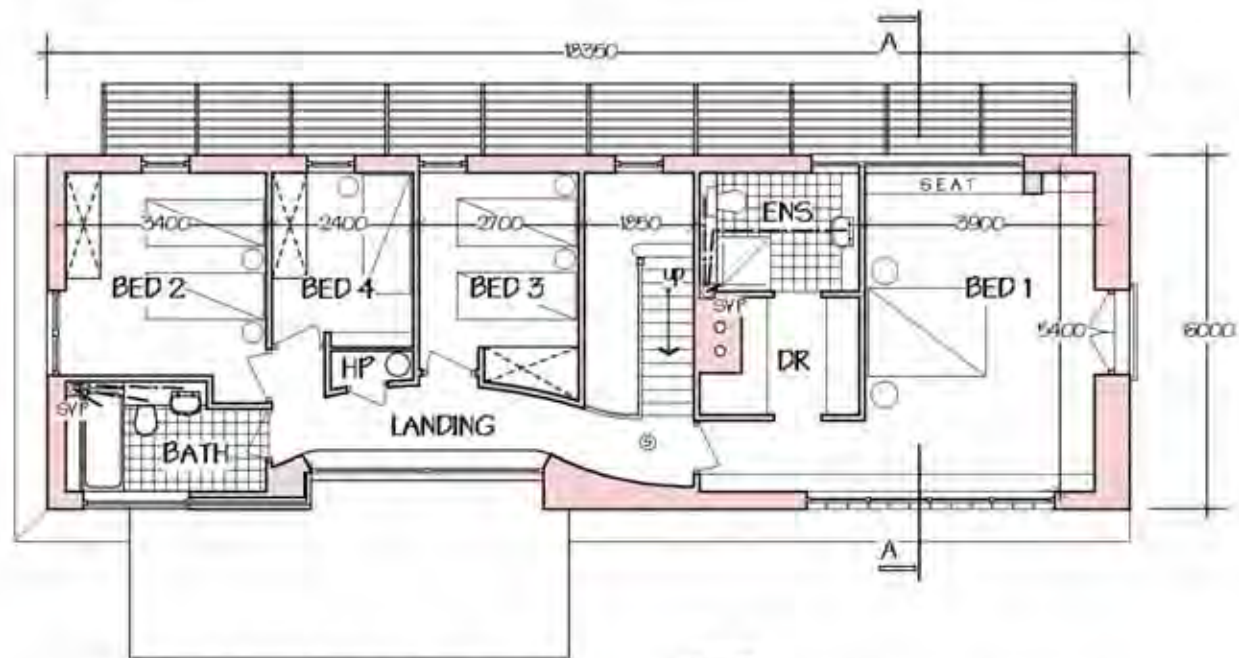

FIRST FLOOR PLAN

NOTE:
 ZNo - smoke alarms shown for precautionary purposes or this illustration i.e. not a Planning Regulation Requirement, warranted by the semi-open plan nature of this house layout and the Irish Building Regulation requirement that the stairs to 1st floor accommodation in houses is enclosed.

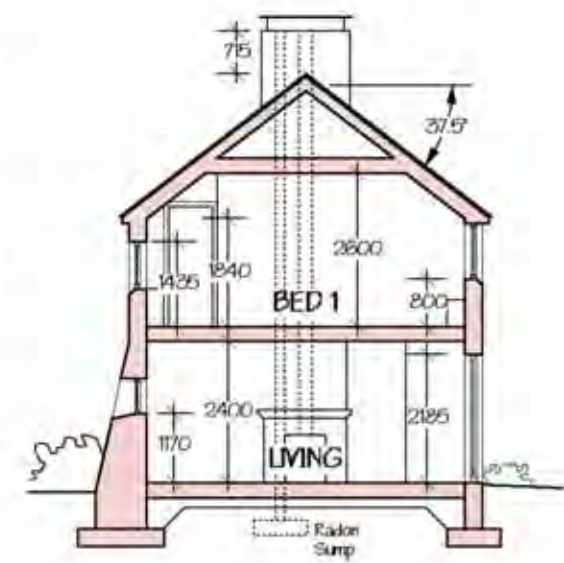

SECTION A-A

ISSUE			PROJECT				ARCHITECTS	
Rev	Amendment	Date	NEW HOUSE AT CUAM, BALLYMACKAY, FERMOY. For S & M MORIARTY				G. ANDRAUGH & PARTNERS	
			Drawing: GR FLOOR PLAN NORTH ELEVATION	Scale: 1 : 100	Date: OCT 2002	Drawing No: 2002/P/ 04	1 THE OSBORN HOUSE, FERMOY, CO. DUBLIN TEL: 0221 565555 FAX: 0221 565555	

checklist for planning applications

have you included:

Completed Application Form?

Page of newspaper containing advert?

Copy of the erected site notice?

A plan showing the position of the site notice?

6 copies of location map to a scale not less than 1:1250, identifying the site in colour and showing the level or contours of the land? (maps shall include Ordnance Survey sheet number, north point and scale)

A schedule listing all plans, maps and drawings?

6 copies of the Site Characterisation Form including test hole layout plan ?

6 copies of site layout plan at a scale not less than 1:500 showing adjoining land in blue and wayleaves in yellow; site boundary in red; identifying all buildings, roads, septic tanks, well stands of trees etc; marking distance of buildings from site boundaries?

6 copies of drawings of floor plans of scale not less than 1:200, indicating dimensions and the name and address of person who prepared them?

6 copies of drawings of all elevations of scale not less than 1:200, depicting dimensions and height of overall building and the name and address of the person who prepared them?

The appropriate fee?

addressing the deep plan house an interpretation of the guide

by Mary Kerrigan Frank Harkin Architects and Project Management

In order to augment the design guidance within the document, CBP commissioned an architectural practice from outside the Cork region to interpret the guidance material, with the specific objective of addressing the very difficult design challenge of the deep plan two storey rural house. Mary Kerrigan Frank Harkin Architects, a registered practice with the RIAI with a track record of producing innovative and contemporary interpretations of the Irish rural house, was directed to develop one possible design approach to address the big box effect of the double deep plan, interpreting the guidance offered in the document on issues of scale, form, proportion, finishes etc. The practice was directed to work to a plan depth of nine metres accommodating a full two storey house and conservatory. Worked up sketches of both a two storey and a one and a half storey interpretation of the double deep plan house are featured overleaf.



This solution offers a fusion between the traditional and the contemporary as an adaptation of the rectangular box plan. Efforts have concentrated on achieving a less dominant primary roof form that is in harmony with the scale and proportions of the traditional farmhouse. This has been achieved by setting the horizontal external gable dimension at 7.5m with a 37.5o double pitched roof. The additional internal floor area has been achieved by adding a contemporary interpretation of a rear "lean-to". By handling this element in a very contemporary manner it is possible to marry a flat roof (either finished in lead or pvc membrane) with the traditional form of the rest of the house. The introduction of this contemporary intervention offers the opportunity for the rear wall to be treated entirely differently from the rest of the house both in terms of finishes and relationship of solid to void. Whilst shown below as a two storey option, the same house can easily be applied to the storey and a half with no change to the footprint. This is depicted on the opposite page as a storey and a half incorporating a contemporary reinterpretation of the eaves dormer.

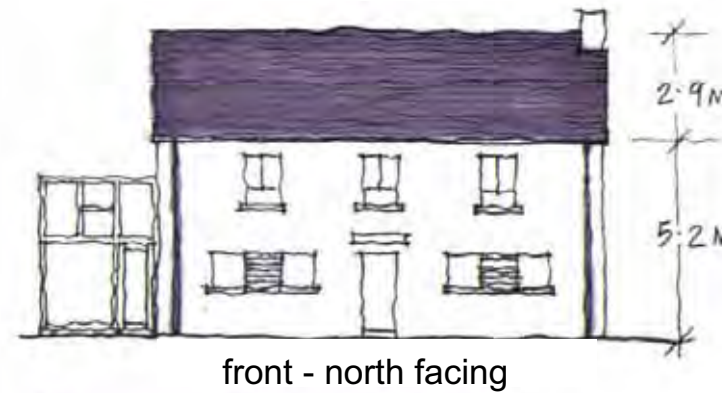
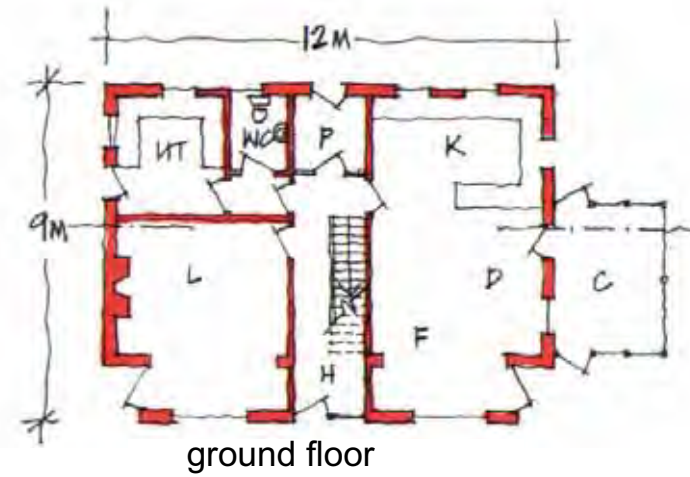
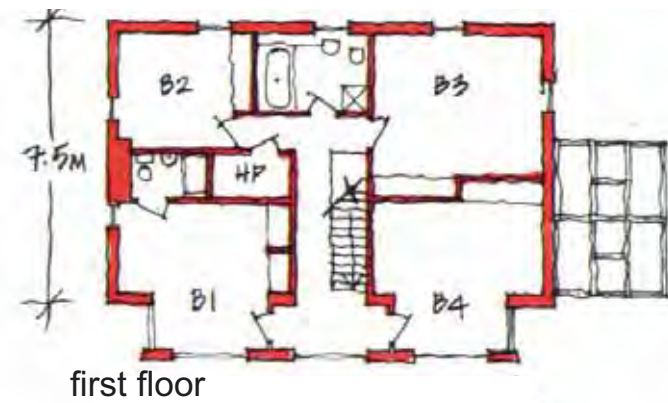

There is scope for adaptation to other orientations. If the traditional front of the house facing the road has a southerly aspect, primary spaces could be relocated to the southside allowing for lower window sill heights for passive solar gain

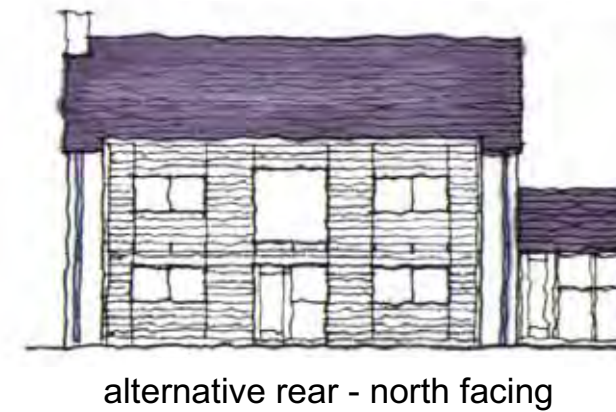

The proposed wall cladding materials are untreated durable timber boarding such as cedar wood, oak or iroko. These will weather to a soft silvery grey colour.

2 Storey House - 186 m² or (2000 sq ft) plus conservatory

© Mary Kerrigan Frank Harkin Architects and Project Management

The use of a flat roof to help achieve the depth in the plan form, whilst retaining a 37.5° roof pitch, is a challenging concept not to be deployed lightly in everyday commissions. Indeed, planners within the County will in most instances recommend great caution in their use, unless they can be demonstrated by a skilled hand, as in this case, to be an integral part of the design solution. Careful detailing is critical to their success as a design element. Where such an element cannot be handled skillfully, designers should revert to the more conventional design solutions advised for the deep plan form, illustrated on pages 66 and 67 of the document.



***for alternative solutions to the deep plan house see pages 66 and 67**

new boundary planting

Below is a list of trees and shrubs suitable for countryside hedgerows and shelterbelts. This list is not exhaustive, but gives an indication of some of the appropriate species to consider when planting for shelter.

name	suitability	advantages	disadvantages
Alder <i>Alnus glutinosa</i>	Streamside, damp or waterlogged	Fast growing, easy to establish, good in clay, fill and wet soils	Will not flourish in stagnant water
Ash <i>Fraxinus excelsior</i>	Open woodland and hedgerows	Good in windswept, exposed and coastal sites	Will not grow in shade
Birch <i>Betula</i>	Good pioneer species, open and woodland sites	Good in damp and poor soils, for sheltering slower growing species.	
Blackthorn <i>Prunus spinosa</i>	Hedgerows, woods, banks and dense thickets	Good in stoney soils, windswept, exposed and coastal sites, stockproof	
wild Cherry <i>Prunus avium</i>	Woods and hedgerows	Attractive blossom and foliage, easily established	
Crab Apple <i>Malus sylvestris</i>	Good in hedgerows	Attractive blossom, form and foliage, easily established	Requires open location
Elder <i>Sambucus nigra</i>	Good in hedgerows and woodlands	Fast growing, tolerates exposed conditions. Berries edible	
Elm <i>Ulmus glabra</i>	Good in hedgerows and woodland	Fast growing, tolerates exposed conditions	Dislikes dry sites, prone to Dutch Elm disease
Gorse <i>Ulex europaeus</i>	Hedgerows and scrub	Evergreen, fast growing, good protection for saplings	
Guelder rose <i>Viburnum opulus</i>	Hedgerows and woodland edges	Attractive blossom, form and foliage	
Hawthorn <i>Crataegus monogyna</i>	Hedgerows and scrub	Good protection for saplings, deters livestock	Dislikes acid soils and wet sites
Hazel <i>Corylus avellana</i>	Hillsides, woodland understorey	Coppices easily, prevents erosion Form thin, hillside soils	Dislikes acid soils
Holly <i>Ilex aquilifolium</i>	Woodlands	Evergreen, tolerant of exposure	Dislikes wet sites, difficult to establish
Honeysuckle <i>Lonicera periclymenum</i>	Climber good in hedgerows	Attractive flowers, hardy.	
Oak <i>Quercus</i>	Best on its own or in groups	Tolerates shallow, rocky soils, very windfirm	Needs shelter when young

Privet <i>Ligustrum vulgare</i>	Hedgerows	Easily established, attractive flowers	
Rowan (or Mountain Ash) <i>Sorbus aucuparia</i>	Woodlands, hillsides	Hardy, tolerant of exposure, attractive flowers and berries	Prefers dry sites
Whitebeam <i>Sorbus Intermedia</i>	Woodland, rocky ground	Tolerant of coastal exposure, attractive foliage and flowers	As Rowan but better tolerance of damp soils
Willow <i>Salix</i>	Stream sides and damp sites	Fast growing, good shelter and screen trees	Cannot survive permanent waterlogging

non-native trees(introduced naturalised species)

Beech <i>Fagus sylvatica</i>	Single trees, shelter belts	Salt tolerant, will grow in shade	Grows best when 'nursed'
Fuschia <i>Fuschia magellanica</i>	Good in hedgerows	Attractive flowers and foliage	
Larch <i>Larix</i>	Single trees and plantations	Deciduous, conifer, withstands exposure, deep rooted	
Lime <i>Tilia vulgaris</i>	Single trees, woodland	Attractive form	Needs shelter when young
Horse Chestnut <i>Aescus hippocastanum</i>	Woodland, single trees	Attractive form, flowers and autumn colour	
Sweet chestnut <i>Castanae sativa</i>	Woodland	Fast growing, easily coppiced	Suffers from cold and exposure

conifers

Scots Pine <i>Pinus sylvestris</i>	Single trees and groups	Attractive foliage, good on dry, rocky and acid soils	Dislikes lime and wet peat
Corsican Pine (or Black Pine) <i>Pinus nigra</i>	Single trees and groups	Good shelterbelt, salt tolerant, good on limestone and sand	Not windfirm on clay
Juniper <i>Juniperis communis</i>	Single trees and groups	Open moorland and chalky soils, good shelterbelt. Edible berries.	
Lodge Pole Pine <i>Pinus contorta</i>	Windswept areas	Fast growing, very tolerant, good on damp soils	
Yew <i>Taxus baccata</i>	Single trees and groups	One of the first trees to bloom each year	

bibliography

Aalen et. al.(eds.) (1998), Atlas of the Irish Rural Landscape Cork University Press

An Taisce, Housing in West Cork –Design Guidelines, 1995

Association for the Protection of Rural Scotland (1997) Changing places -The Design and Siting of Housing in Rural Scotland

Becker, A, Olley, J, Wang, W (1997) 20th Century Architecture Ireland, Prestel

Borders Regional Council (1993), New Housing in the Borders Countryside, Policy and Guidance Note December 1993, Planning and Development Department.

Brecon Beacons National Park Committee (1988), Building Design: A Guide for Developers, Brecon Beacons National Park, Wales

Chandler, R, Doyle, D, Gibney, A, McDonnell, R and O'Regan, A (1980) The Roadstone Book of House Designs, Roadstone Ltd.

Council for the Protection of Rural England (1996), Local Attraction: the design of new housing in the countryside CPRE, London

Department of the Environment of Northern Ireland (1994), A Design Guide for Rural Northern Ireland, Town and Country Planning Service, Belfast: HMSO

Department of the Environment Northern Ireland, Dwellings in the Mournes: a Design Guide, DoE Countryside and Wildlife Branch, Belfast

Earley, J MSc (1998) Trees and Hedgerows, Cork County Council

Essex Planning Officers Association (1997), The Essex Design Guide for Residential and Mixed Use Areas, Essex County Council, England

Fladmark, J.M., Mulvagh, G.Y. & Evans, B.M.(1991), Tomorrow's Architectural Heritage –landscape and buildings in the countryside, Mainstream Publishing Company (Edinburgh) Ltd

Fladmark, J.M., Hill, B.M. & Donald, J (1994), Landscape & Architecture: Basic Design for Decision Makers, Scottish Natural Heritage and Scottish Homes (draft)

Galway County Council Design Guidelines for the Single Rural House - Appendix to the County Development Plan 2003-2009

Geoghegan, Philip and Delphine (1997), Building Sensitively and Sustainably in County Louth: landscape, settlement and building tradition, Louth County Council, (Published by Louth County Council as a support and clarification of the policies for housing location in the County Development Plan, 1997).

Geoghegan, Philip and Delphine (1997), Design Guidelines for Single Houses in the Countryside, Louth County Council

Harper, P, Light, J, Masden, C (1994), The Natural Garden Book: Gardening in Harmony with Nature Gaia Books Ltd.

Kerry County Council, Building in Rural Areas - Appendix H to the Kerry County Development Plan

McCullough, N and Mulvin,V (1987), A Lost tradition: the Nature of Architecture in Ireland, Gandon Editions Dublin

Moray District Local Plan 1993-1998: Housing in the Countryside, Moray District Council, Scotland

Naismith, Robert J. (1989), Buildings of the Scottish Countryside, Countryside Commission of Scotland, Victor Gallancz, London

Ni Lamhna, E (2002), Talking Wild, Town House and Country House Ltd

Peak National Park (1987), Building Design Guide

Perth and Kinross District Council (1995), Guidance on the Siting and Design of Houses in Rural Areas

Roche, N. (1999), The Legacy of Light - a History of Irish Windows, Wordwell Ltd.

Rothery, S. (1997) The Buildings of Ireland, The Lilliput Press Ltd.

Royal Incorporation of Architects in Scotland (1993), Fields of Vision – New Ideas in Rural House Design, RIAS Edinburgh

Shaffrey, Patrick and Maura (1985) Irish Countryside Buildings - everyday architecture in the rural landscape, O'Brien Press Dublin

The Scottish Executive (1991), Designing Places: a policy statement for Scotland

The Scottish Office (1991), Siting and Design of New Housing in the Countryside, PAN 36, HMSO, Edinburgh

The Scottish Office (1994), Fitting New Housing Development into the Landscape, PAN 44, HMSO, Edinburgh

The Scottish Office (1998), Investing in Quality: improving the design of new housing in the Scottish Countryside (a consultation paper)

UCD School of Architecture, Building Sensitively in Ireland's Landscapes, prepared by the Housing and Urban Design Research Institute, published by Bord Failte, An Taisce & Galway County Council

Irish Architecture Journals and Annuals and various publications by the RIAI

picture credits

photo and design credits

colin buchanan and partners ltd

Photographs

4, 5, 6, 7, 17, 18, 19, 20, 23, 28, 29, 30, 37, 54,60, 61, 62, 63, 65, 66, 68, 91, 93, 95, 99,105, 106, 107, 108, 109, 110, 111, 112, 113, 119, 122, 129, 135, 136, 162.

mike shanahan + associates, architects

Photographs

1, 2, 3, 10, 11, 12, 13, 15, 21, 22, 24, 25, 26, 27, 31, 32, 33, 34, 35, 36, 40, 42, 44, 45, 46, 47, 48, 50, 51, 52, 53, 55, 56, 57, 58, 59, 64, 67, 69, 70, 71, 72, 73, 74, 75, 76, 77, 88, 89, 90, 92, 94, 96, 97, 98, 100, 114, 115, 116, 117, 118, 120, 121, 123, 124, 125, 126, 127, 128, 130, 131, 133, 134, 137, 138, 139, 140, 141, 142,143,145, 146,147, 148, 149, 150, 151, 152, 153, 155, 156, 157, 158, 159, 160, 161, 163, 164, 165,167,168,169,170,172,173,174,175.

design credits - houses featured

Every effort has been made to credit correctly the houses which appear in the Guide. Any omissions or inaccuracies should be brought to the attention of the Planning Policy Unit, details at front.

1 Niall Hyde Architect

8 John Dorman Architects (Photo courtesy of John Dorman Architects)

9 Michael Williams Associates (Photo courtesy of Michael Williams Associates)

11 Donal Hoare Architect

14 Simon Conolly, Akiboye Conolly Architects (Photo courtesy of Akiboye Conolly Architects)

15 SSA Architects

16 Tony Kelly, Wilson Architecture (Photo courtesy of Wilson Architecture)

17 D. Anderson, Diamond Redfern Anderson

22 W. Sutchbury (Extension)

24 Donal Hoare Architect

26 SSA Architects

29 Caroline Dickson Architects

47 Niall Hyde Architect
48 MSA Architects
49 Pat McCabe of Simon J Kelly + Partners Architects (Photo courtesy of Simon J Kelly + Partners)
51 Kees van Dam Architect
53 Kees van Dam Architect
55 Nick & Elaine Brown Architects
59 Cork County Council Architects
78 Roisin Murphy, Warren Architecture and Interiors (Photo courtesy of Warren Architecture and Interiors)
79 Roisin Murphy, Warren Architecture and Interiors (Photo courtesy of Warren Architecture and Interiors)
80 Pat McCabe, Simon J Kelly + Partners Architects (Photo courtesy of Simon J Kelly + Partners Architects)
81 Paul Keogh, Paul Keogh Architects
82 Shelley McNamara & Yvonne Farrell, Grafton Architects
83 Prof Kulka and Daly Barry Associates (Photo courtesy of Daly Barry Associates)
84 Mary Kerrigan Frank Harkin Architects and Project Management (Photo courtesy of Mary Kerrigan Frank Harkin Architects and Project Management)
85 Michael Williams Associates (Photo courtesy of Michael Williams Associates)
86 Mary Kerrigan Frank Harkin Architects and Project Management (Photo courtesy of Mary Kerrigan Frank Harkin Architects and Project Management)
87 Tony Kelly, Wilson Architecture (Photo courtesy of Wilson Architecture)
94 OPW Architects
98 Geoffrey Bainister Architect
101 Tom Hegarty, O'Riordan Staehli Architects
102 Tom Hegarty, O'Riordan Staehli Architects
103 Tom Hegarty, O'Riordan Staehli Architects
104 Prof Kulka and Daly Barry Associates
105-113 D. Anderson, Diamond Redfern Anderson
114 Donal Hoare Architect
119 Orna Hanly Architects
120 D.Anderson, Diamond Redfern Anderson
121 MSA Architects
123 Cork County Council Architects
125 OPW Architects (TBC)
129 Orna Hanly Architect
130 D.Anderson, Diamond Redfern Anderson
131 unknown
132 Prof Kulka and Daly Barry Associates (Photo courtesy of Daly Barry Associates)
133 Cole Partnership
135 Caroline Dickson Architects
136 Orna Hanly Architect

137 Cork County Council Architects
138 Niall McLaughlin Architects
140 MSA Architects
141 WA Houlihan Architect
142 MSA Architects
143 D.Anderson, Diamond Redfern Anderson
144 Michael Williams Associates (Photo courtesy of Michael Williams Associates)
145 SSA Architects
146 SSA Architects
147 Fourem Design
149 D.Anderson, Diamond Redfern Anderson
150 Cork County Council Architects
151 Cork County Council Architects
152 unknown
153 unknown
154 Tom Hegarty, O'Riordan Staehli Architects
155 WA Houlihan Architect
157 Frank Murphy & Partners
160 W. Stutchbury, SSA Architects
164 W. Stutchbury, SSA Architects
166 Tony Kelly, Wilson Architecture (Photo courtesy of Wilson Architecture)
168 MSA Architects
171 Pat McCabe, Simon J Kelly + Partners

acknowledgements & accreditation

The authors would like to thank the following for their contribution to this guide:

The **Cork County Council Design Steering Group** for their commission and direction, ongoing advice and input and their commitment to this project:

- William A. Houlihan - County Architect
- Patricia Power - Director of Service, Northern Division
- John Clements - Executive Planner, Planning Policy Unit

The **Project Team** for their professionalism, dedication and tireless passion for the subject throughout this project:

Colin Buchanan and Partners Ltd - project management, graphic design and layout of guide, text, photographs and editing:

- Paul Mc Ternan - Associate Director (Planning)
- Lisa Grainger - Principal Planner/Urban Designer
- Gary Rowan - Senior Planner
- Alma Clavin - Graduate Planner
- Aoife Curran - Graphic Design

Mike Shanahan + Associates, Architects - design and illustrations (all sketches except where otherwise noted), narrow plan worked example, text, photographs and editing:

- Michael Shanahan - Architect, Director
- Margaret Walsh - Architect, Director
- Patrick Sullivan - Senior Architectural Technican
- Liam Morrissey - Architectural Technican
- Anthony Hayes - Graduate Architect

A special thanks is accorded to **Mary Kerrigan Frank Harkin Architects and Project Management** - for their interpretation of the guidance in respect of the deep plan house in the appendices. The contribution of Mary Kerrigan - Architect/Partner, Frank Harkin - Architectural Technologist/Partner and Joanne Dooher - Architectural Assistant are acknowledged.

The authors express their gratitude to all of those who kindly submitted photographic and sketch material for inclusion in the document (listed within the Picture Credits). In particular the assistance of the RIAI Southern Region and its then chairman Paul Hudson are acknowledged as are the contributions of many of the officers at Cork County Council who provided valuable input to the various drafts of the Guide.

The authors would also like to acknowledge the writing and work of W. Stutchbury Architect, which proved an inspiration to the design team, together with the seminal design guidance works of The Moray Council in Scotland and Essex County Council in England.

PLANNING
GUIDANCE AND STANDARDS SERIES



**No. 1: CORK RURAL DESIGN GUIDE:
BUILDING A NEW HOUSE IN THE
COUNTRYSIDE** - DECEMBER 2003

No. 2: RESIDENTIAL ESTATES DESIGN GUIDE
- In preparation

TITLES IN THE SERIES

*Further information on the Planning
Guidance and Standard Series can be
obtained from:*

The Planning Policy Unit
Floor 13
County Hall
Cork.
Tel: 021 4285 900

This document is part of Cork County Council's Planning Guidance and Standards Series. The series gives technical guidance and background information on a wide range of planning topics relevant to County Cork and is an important resource for those involved in the planning and development sectors. In giving a practical everyday context to many of the policies and objectives in the County Development Plan, the documents will also be valuable for people who have a more general interest in planning and in the ongoing development of the county.

Cork County Council
Planning Policy Unit



"If you are thinking of buying a rural site, involved in selecting or designing a house for a particular site, or just interested in County Cork's heritage and future development, then this guide is for you..."

€20



www.corkcoco.ie